

## Original installation and operation manual

**BEKOMAT® 12i**  
**BEKOMAT® 12i CO**  
**BEKOMAT® 12i CO PN63**

- > BM12i
- > BM12iCO
- > BM12iCOPN63

## ■ Table of contents

<b>1. Notes about the documentation .....</b>	<b>5</b>
1.1 Contact .....	5
1.2 Information about this installation and operation manual .....	5
<b>2. Safety .....</b>	<b>6</b>
2.1 Use .....	6
2.1.1 Intended use .....	6
2.1.2 Reasonably foreseeable inappropriate use .....	7
2.2 Responsibility of the operating company .....	7
2.3 Target group and personnel .....	8
2.4 Explanation of the safety symbols used .....	9
2.5 Safety instructions and warning notices .....	10
2.5.1 Safe operation .....	10
2.5.2 Pressurised systems .....	10
2.5.3 Electric voltage .....	11
2.5.4 Transport and storage .....	11
2.5.5 Installation .....	11
2.5.6 Maintenance .....	12
2.5.7 Handling hazardous substances .....	12
2.5.8 Use of spare parts, accessories or materials .....	13
2.6 Warning notices .....	13
<b>3. Product information .....</b>	<b>14</b>
3.1 Exploded view BEKOMAT® 12i, BEKOMAT® 12i CO .....	14
3.2 Exploded view BEKOMAT® 12i CO PN63 .....	16
3.3 Product overview .....	18
3.4 Function description .....	19
3.5 Modbus function .....	20
3.5.1 Default interface parameters .....	20
3.5.2 Byte sequence .....	20
3.5.3 Implemented functions .....	20
3.5.3.1 Read Input Registers (0x04) .....	21
3.5.3.2 Read Device Identification (0x2B / 0x0E) .....	22
3.5.3.3 Changing interface parameters .....	23
3.5.3.4 Control commands .....	24
3.5.3.5 Error messages .....	24
3.6 Type plate .....	25
3.7 Scope of delivery .....	26

<b>4. Technical data</b>	<b>27</b>
4.1 Operating parameters	27
4.2 Storage and transportation parameters	28
4.3 Materials	28
4.4 Dimensions BEKOMAT® 12i, BEKOMAT® 12i CO	28
4.5 Screw fastening torques BEKOMAT® 12i, BEKOMAT® 12i CO	29
4.6 Dimensions BEKOMAT® 12i CO PN63	30
4.7 Screw fastening torques BEKOMAT® 12i CO PN63	31
4.8 Installation dimensions	32
4.9 Terminal diagram power control board	32
<b>5. Transport and storage</b>	<b>33</b>
5.1 Transport	33
5.2 Storage	33
<b>6. Assembly</b>	<b>34</b>
6.1 Warning notices	34
6.2 Assembly conditions	35
6.3 Assembly work	37
<b>7. Electrical installation</b>	<b>39</b>
7.1 Warning notices	39
7.2 Connection work	40
7.2.1 Single device connection	41
7.2.2 Connecting multiple Modbus devices (series connection)	43
<b>8. Commissioning</b>	<b>45</b>
8.1 Warning notices	45
8.2 Commissioning work	46
<b>9. Operation</b>	<b>47</b>
9.1 Warning notices	47
9.2 Operating states	48
<b>10. Maintenance</b>	<b>50</b>
10.1 Warning notices	50
10.2 Maintenance schedule	51
10.3 Maintenance work	51
10.3.1 Wear part replacement	52
10.3.2 Functional test	57
10.3.3 Visual inspection	57
10.3.4 Leakage test	57
10.3.5 Cleaning	58

## ■ Table of contents

<b>11. Consumables, accessories and spare parts</b> .....	<b>61</b>
11.1 Order information.....	61
11.2 Accessories.....	61
11.3 Spare parts.....	62
<b>12. Decommissioning</b> .....	<b>65</b>
12.1 Warning notices .....	65
12.2 Decommissioning work .....	66
<b>13. Dismantling</b> .....	<b>67</b>
13.1 Warning notices .....	67
13.2 Dismantling work.....	68
<b>14. Disposal</b> .....	<b>69</b>
14.1 Warning notices .....	69
14.2 Disposal of operational materials and components.....	70
<b>15. Troubleshooting and fault repair / FAQ</b> .....	<b>71</b>
<b>16. Appendices</b> .....	<b>72</b>
16.1 Approval certificates and declarations of conformity.....	72
16.2 Declaration of Conformity.....	74




# 1. Notes about the documentation


This documentation contains all the necessary steps for use and operation of the product and the accessories.

## 1.1 Contact

Manufacturer	Customer service and tools
<b>BEKO TECHNOLOGIES GmbH</b>  Im Taubental 7   41468 Neuss Tel. +49 2131 988-1000 info@beko-technologies.com www.beko-technologies.com	<b>BEKO TECHNOLOGIES GmbH</b>  Im Taubental 7   41468 Neuss Tel. +49 2131 988-1000 service-eu@beko-technologies.com www.beko-technologies.com

INFORMATION	Country-specific manufacturer representation
	You can contact the country-specific manufacturer's representative via the address listed in the address section on the rear cover or by using the contact form on the manufacturer's website.


## 1.2 Information about this installation and operation manual

INFORMATION	Copyright protection!
	The contents of the installation and operation manual in the form of text, figures, illustrations, photographs, technical drawings, diagrams and other representations are protected by the copyright of the manufacturer. This applies especially to duplication, reproduction, microfilming and storage as well as processing in electronic systems.

Publication date	Revision	Version	Reason for amendment	Scope of amendment
18 May 2021	01	00	Editorial revision	Editorial changes
30 June 2021	02	00	Change in technical data	Change in technical data
25 November 2021	03	00	Change in housing class	Chapter 3.6 and 4.1

The installation and operation manual, hereinafter referred to as the manual, must always be kept close to the product and be in a permanently legible condition.

The manual must be handed over along with the product if it is sold or passed on.

NOTE	Follow the instructions given in the manual!
	This manual contains all the basic information required for safe operation of the product and must be read before any actions are performed. Otherwise personal and material hazards as well as malfunction and device failure are possible.

## 2. Safety

### 2.1 Use

The **BEKOMAT® 12i / 12i CO / 12i CO PN63**, also referred to as product or **BEKOMAT®** below, has been designed for draining condensate from low pressure systems and pressureless vacuum systems. The **BEKOMAT®** is able to drain condensate at operating pressure with no pressure loss.

#### 2.1.1 Intended use

Any use of this system other than the use described in this manual is hereby deemed to be non-intended and can cause a hazard for the safety of people and the environment.

The following must be noted for intended use:

- Read and follow the manual.
- Only use the product and the accessories in indoor areas.
- Only use the product and accessories within the operating parameters given in the technical data and the agreed delivery conditions.
- Only use the product and accessories with media which are free of caustic, aggressive, corrosive, toxic, flammable, oxidising or inorganic components.
- In cases of doubt an analysis must be carried out.
- Only use the product and accessories in surroundings where splash water is the maximum possible water exposure that can occur. The splash water must be free of corrosive components.
- Only use the product and accessories in areas which are free of toxic and corrosive chemicals and gases.
- Only use the product and accessories within the piping system designed for the technical data with appropriate connections, pipe diameters and assembly clearances
- Only use the product and accessories outside potentially explosive atmospheres.
- Only use the product and accessories away from direct solar radiation and heat sources as well as areas subject to frost.
- Only combine the product and accessories with the products and components named and recommended by **BEKO TECHNOLOGIES** in the manual.
- Adhere to the prescribed maintenance schedule.

Before using the product and the accessories, the operating company must make sure that all conditions and prerequisites for intended use are given.

The product and the accessories have been exclusively designed for stationary use in a commercial or industrial area. All of the assembly, installation, operation, maintenance, disassembly and disposal work described may only be performed by qualified skilled technical personnel.

## 2.1.2 Reasonably foreseeable inappropriate use

Reasonably foreseeable inappropriate use is deemed to have occurred if the product or the accessories are used in any other way than that described in the chapter "Intended use". Reasonably foreseeable inappropriate use includes the use of the product or the accessories in a manner not intended by the manufacturer or supplier but which may result from foreseeable human behaviour.

Reasonably foreseeable inappropriate use includes:

- The execution of any kind of modification, in particular constructive and process-technology related interventions.
- The suspension, bridging or non-application of existing or recommended safety equipment.

This list is not exhaustive as not all possible inappropriate use can be foreseen in advance. If the operating company is aware of any inappropriate use of the product or accessories which are not listed here, the manufacturer must be informed immediately.


## 2.2 Responsibility of the operating company

The responsible operating company must ensure the following to prevent accidents, incidents and adverse effects on the environment:

- Before all actions, check to ensure that the manual available does in fact belong to the product.
- The product and the accessories are used, serviced and repaired in accordance with the intended use.
- The product and accessories are only used with the recommended and fully operable safety equipment.
- All assembly, installation and maintenance work is carried out by qualified skilled technical personnel only.
- Personnel have the necessary personal protective equipment available and also use this equipment.
- Suitable technical safety measures are taken so that the permissible operating parameters are adhered to.
- Keep all safety symbols and the type plate on the product in a legible state. Replace damaged and illegible marking immediately.

## 2.3 Target group and personnel

This manual addresses the personnel listed below who are involved with work on the product or the accessories.

<b>INFORMATION</b>	<b>Personnel requirements!</b>
	The personnel may not execute any actions on the product or the accessories when they are under the influence of drugs, medications, alcohol or other substances that may impair their consciousness.

### Operating personnel

Operating personnel are persons who are able to operate the product and the accessories safely on the basis of knowledge of the manual and instruction at the product and accessories. Operating personnel can recognise possible malfunctions and dangerous situations independently and arrange for corresponding measures.

### Skilled technical personnel - transport and storage

Skilled technical personnel - transport and storage are people who, due to their training, professional experience and qualifications, have all the necessary skills to safely execute all actions in connection with the transport and storage of the product, to instruct, to recognise possible dangerous situations independently and to execute measures to avoid danger.

The capabilities include, in particular, experience with hoists, forklifts and lifting equipment and knowledge of local laws, standards and guidelines relating to transport and storage.

### Skilled technical personnel - pressure equipment and plants

Skilled technical personnel - pressure equipment and plants are people who, due to their training, professional experience and qualification, possess all the necessary capabilities to safely execute actions, and instruct all actions related to pressurised fluids and systems, to independently foresee potential hazardous situations and implement appropriate measures to avert any danger.

The capabilities include, in particular, experience in handling measuring technology and control technology as well as knowledge of the regionally applicable laws, standards and regulations for pressurised systems.

### Skilled technical personnel - electrical engineering

Skilled technical personnel - electrical engineering are people who, due to their training, professional experience and qualification, have all the necessary capabilities to safely execute all actions related to electricity, to instruct and to independently foresee potential hazardous situations and take appropriate measures to avoid any danger.










The capabilities include, in particular, experience in handling electric voltage plants, measurement and control technology as well as knowledge of the regionally applicable laws, standards and regulations (e.g. VDE 0100 / IEC 60364 / ATEX) applicable for handling electrical technology.

### Skilled technical personnel - customer service

Skilled technical personnel - customer service are people who have the skills and qualifications of the skilled personnel definitions named above. Skilled technical personnel - customer service must have documented proof of training for all work on the product and be authorised.

## 2.4 Explanation of the safety symbols used

The symbols used below indicate safety-relevant and important information which must be adhered to when handling the product and to ensure safe and optimum operation.

Symbol	Description / explanation
	General warning symbol (danger, warning, caution)
	Warning: pressurised system
	Warning: electric voltage
	Observe the installation and operation manual
	General note
	Wear safety footwear
	Use protective gloves (cut-proof and liquid-resistant)
	Wear safety goggles with side shields
	General information

## 2.5 Safety instructions and warning notices

This chapter provides an overview of all the important safety aspects for personal protection as well as for the safe and problem-free operation of the product and accessories.

The following chapters list the dangers posed by this product and the accessories even with intended use. To minimise the risk of personal injury and damage to property and to avoid dangerous situations, observe the safety instructions listed and adhere to the warning notices in the other chapters of this manual.

Basic warning notices and the necessary qualifications of skilled technical personnel are always listed at the beginning of the chapter in the "Warning notices" section.

Warning notices related to specific actions are printed directly before potentially hazardous procedures or sequences of actions.

### 2.5.1 Safe operation

Commissioning and operating the product and accessories outside the permissible limits and operating parameters may result in serious personal injuries or death. Unauthorised interference and unauthorised modifications of the product and accessories may lead to serious personal injuries or death.

To guarantee safe operation of the product and accessories, observe the following points:

- Use suitable protective equipment during all work on the product or accessories.
- Adhere to the limits and operating parameters specified on the type plate and in the manual.
- Adhere to the assembly conditions and ambient conditions.
- Check whether the permissible operating parameters have been amended or restricted by the use of accessories.
- Adhere to the maintenance intervals.

### 2.5.2 Pressurised systems

Contact with quickly or suddenly escaping fluids or bursting plant parts may result in serious personal injuries or death.

For the safe handling of pressurised systems, observe the following points:

- Set up a safety area around the working area during assembly, installation, maintenance and repair work.
- Before starting work, depressurise the pressurised system and secure it against unintentional pressurisation.
- Before pressurisation, check all system pipe connections for leak tightness and tighten if necessary.
- Slowly pressurise the system.
- Avoid pressure blows and high differential pressures.
- Compensate any vibrations occurring in the pipe network by using vibration dampers.

## 2.5.3 Electric voltage

Contact with live components may result in serious personal injuries or death.

To ensure the safe handling of live components, observe the following points:

- Set up a safety area around the working area during all installation and repair work.
- Before starting work, de-energise the product and accessories and secure them against being switched back on again unintentionally.
- Only connect the product and the accessories to the voltage supply if they are undamaged.
- Adhere to all applicable regulations (e.g. VDE 0100 / IEC 60364 / ATEX) during installation.
- Connect the protective conductor (earth connection) according to regulations.
- Only operate the product and accessories with the cover complete and closed or the housing closed.

## 2.5.4 Transport and storage

Inappropriate transport or storage may result in personal injury or damage to property.

For safe transport and storage of the product and accessories, observe the following points:

- Use personal protective equipment during all work with packaging material.
- Handle packaging, the product and accessories carefully.
- Transport and handle the packaged product and accessories according to the markings on the packaging (note lifting gear attachment points, the centre of gravity and alignment e.g. keep vertical, do not throw etc.).
- Only use proper means of transport and lifting equipment that is in proper working order.
- Always adhere to the permissible transport and storage parameters.
- Store the product and accessories only outside of areas exposed to direct sunlight and heat sources.

## 2.5.5 Installation

Inappropriate assembly or electrical installation of the product and accessories may result in personal injury and damage to property as well as impair operation.

For safe assembly and electrical installation, observe the following points:

- Install the product, the accessories, and all parts and materials used so that they are not subject to mechanical tension.
- Check all plug-type connections for a correct fit.
- Avoid a stumbling hazard by routing cables and hoses accordingly.
- Avoid mechanical strain on the cables.
- Fix and fasten hoses in such a way that they cannot flap around.
- Install the feed lines and drain lines as fixed pipes.

## 2.5.6 Maintenance

Inappropriate completion of maintenance and repair work may result in serious personal injuries or death.

For safe maintenance and repair, observe the following points:

- Use suitable protective equipment during all work on the product or accessories.
- Set up a safety area around the working area during all work.
- Before starting work, depressurise the pressurised product and accessories and secure them against unintentional pressurisation.
- Before starting work, de-energise the product and accessories and secure them against being switched back on again unintentionally.
- Only use materials approved for the respective application.
- Use only suitable tools that are in proper working order.
- Only use cleaned pipes and hoses that are free of dirt and corrosion.
- Never use abrasive or aggressive cleaning agents or solvents which could damage the outer coating (e.g. markings, type plate, corrosion protection, etc.).
- Never clean the device with hard or pointed implements.
- Use an anti-static, damp cloth for cleaning the outside.
- Observe the regionally applicable hygiene regulations.
- Pay attention to cleanness and tidiness during maintenance and repair work. Prevent contamination from entering the opened product or accessories. Store the disassembled components and accessories directly in a safe place.
- After completing maintenance and repair work, remove all the tools and cleaning media used as well as all parts that are no longer needed from the work area.
- Only dispose of the product and accessories when cleaned and freed of any media residue.
- Dispose of all components, parts, operating and auxiliary materials as well as cleaning media professionally and in accordance with regional legal specifications and regulations.
- Dispose of electrical and electronic components through a specialist waste disposal company or return to **BEKO TECHNOLOGIES**.

## 2.5.7 Handling hazardous substances

Contact with condensate containing substances which endanger health and the environment can pose a health hazard, causing irritation and/or damage to the eyes, skin and mucous membranes. In addition, polluted condensate must be prevented from entering the sewerage system, waters or the ground.

For the safe handling of polluted condensate the following points must be observed:

- Use suitable protective equipment when handling condensate.
- Pick up and dispose of any leaking or spilled condensate in accordance with applicable regional laws and requirements.



## 2.5.8 Use of spare parts, accessories or materials

The use of incorrect spare parts, accessories or materials, as well as auxiliary and operating materials, may result in death or serious injury. Malfunction and device failure as well as material damage can occur.


- Only use undamaged original parts, auxiliary and operating materials which are specified by the manufacturer to complete all work.
- Only use the materials approved for the respective application and suitable tools in proper working order.
- Only use cleaned pipes that are free of dirt and corrosion.
- Only use electric components and materials that comply with regionally applicable specifications and regulations (standards, directives etc.) for electrical safety.

## 2.6 Warning notices

Warning notices warn against dangers when handling the product and accessories.

In order to prevent accidents, personal injury and damage to property as well as impairments during operation, it is essential to adhere to the warning notices.

### Structural set up:

SIGNAL WORD	Type and source of danger!
 Symbol	Possible consequences if the danger is ignored <ul style="list-style-type: none"> <li>• Measure to prevent the danger</li> </ul>

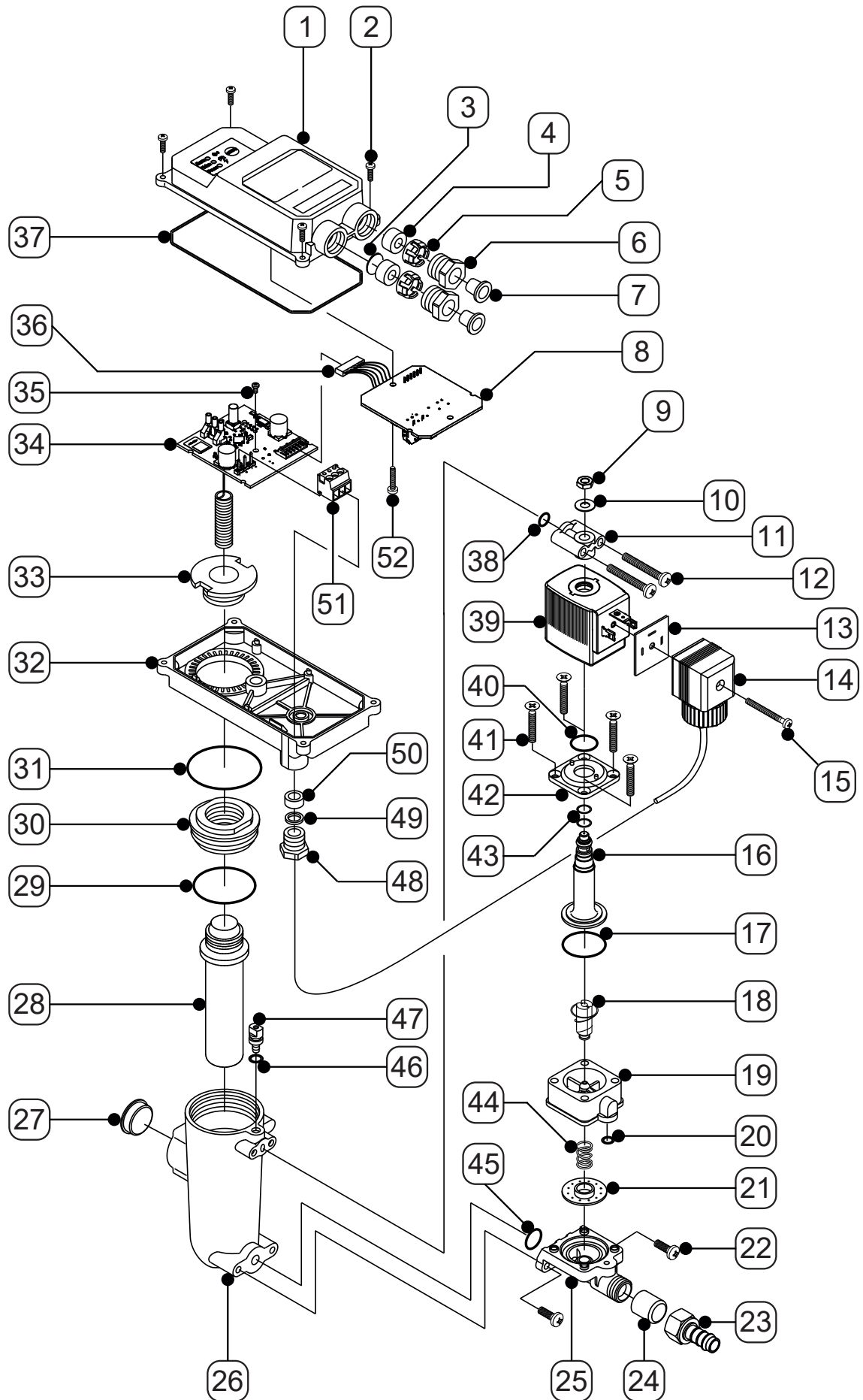
### Signal words:

<b>DANGER</b>	<b>Imminent hazard</b> Consequences of non-compliance: Death or serious personal injury.
<b>WARNING</b>	<b>Imminent hazard</b> Consequences of non-compliance: Death or serious personal injury are possible.
<b>CAUTION</b>	<b>Potential hazard</b> Consequences of non-compliance: Personal injury or damage to property are possible.
<b>NOTE</b>	<b>Additional notes</b> Consequences of non-compliance: Damage to property, malfunction and device failure are possible. No hazard to people or endangerment of safe operation.

## 3. Product information

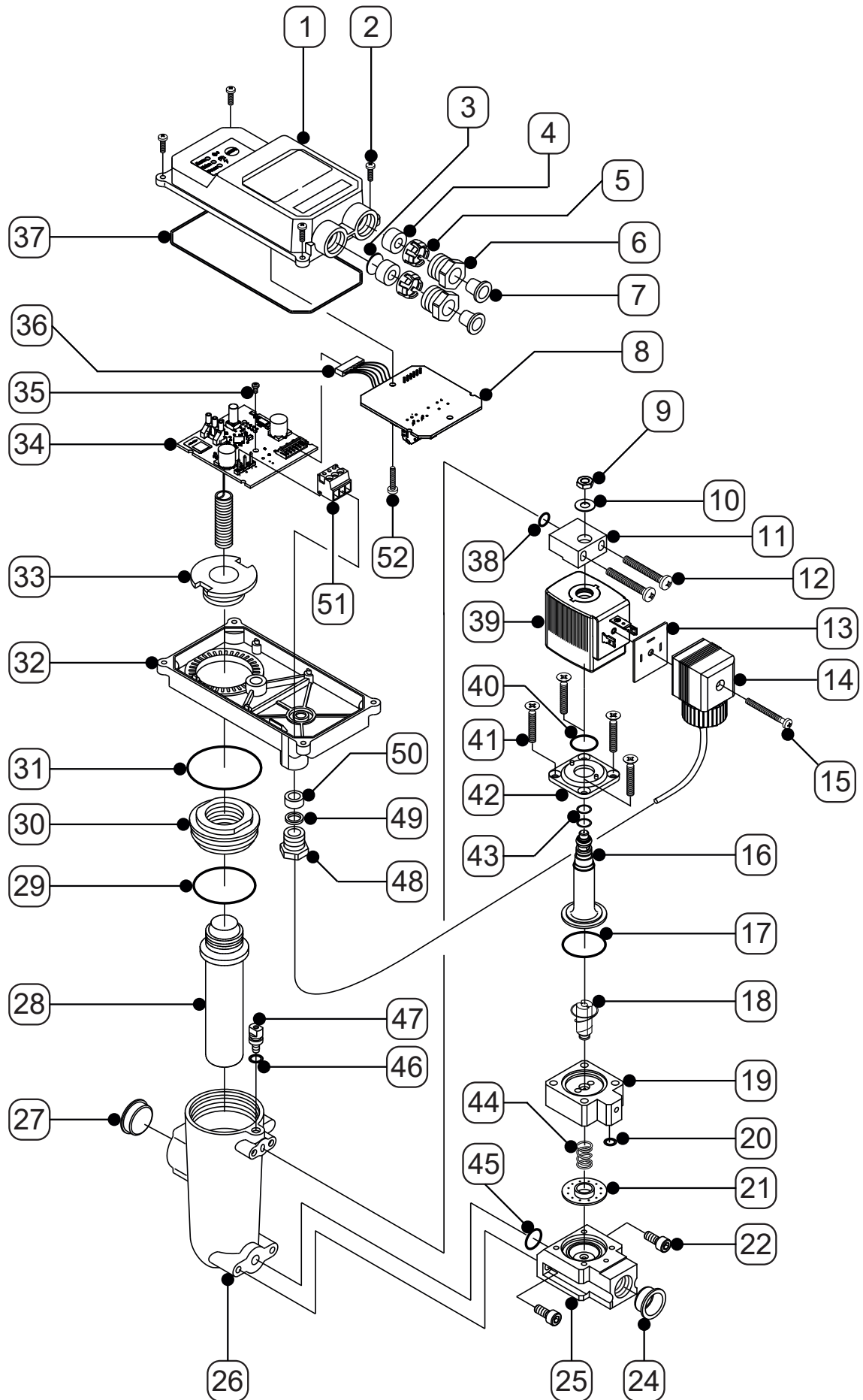
### 3.1 Exploded view BEKOMAT® 12i, BEKOMAT® 12i CO

Item	Description / explanation	Item	Description / explanation
[1]	Top cover	[27]	Plug
[2]	Screw M3 x 10	[28]	Sensor tube
[3]	Dust protection pane	[29]	O-ring 31.42 x 2.62 mm
[4]	Sealing ring PG9	[30]	Fixing screw
[5]	Clamp cage PG9	[31]	O-ring 34.59 x 2.62 mm
[6]	Pressure screw PG9	[32]	Bottom cover
[7]	Plug	[33]	Cover mounting element
[8]	Power control board	[34]	Control circuit board
[9]	Nut M5	[35]	Screw M3 x 6
[10]	Washer	[36]	Cable clamp
[11]	Control air cover	[37]	Cord packing 2 x 315 mm
[12]	Screw M4 x 30	[38]	O-ring 5.5 x 1.5 mm
[13]	Flat gasket	[39]	Solenoid coil
[14]	Solenoid valve connector	[40]	O-ring 11.1 x 1.78 mm
[15]	Fixing screw	[41]	Screw M4 x 25
[16]	Core guide pipe	[42]	Flange
[17]	Oval ring 21.8 x 1.5 x 2.5 mm	[43]	O-ring 5 x 1.5 mm (top) O-ring 6 x 1.5 mm (bottom)
[18]	Valve core with spring	[44]	Pressure spring
[19]	Membrane cap	[45]	O-ring 9.25 x 1.78 mm
[20]	O-ring 5.5 x 1.5 mm	[46]	O-ring 4 x 1.5 mm
[21]	Membrane	[47]	Earthing screw
[22]	Screw M4 x 12	[48]	Pressure screw PG7
[23]	Hose connection	[49]	Pressure ring PG7
[24]	Plug	[50]	Sealing ring PG7
[25]	Membrane seat	[51]	Cable clamp
[26]	Housing	[52]	Screw M3 x 6

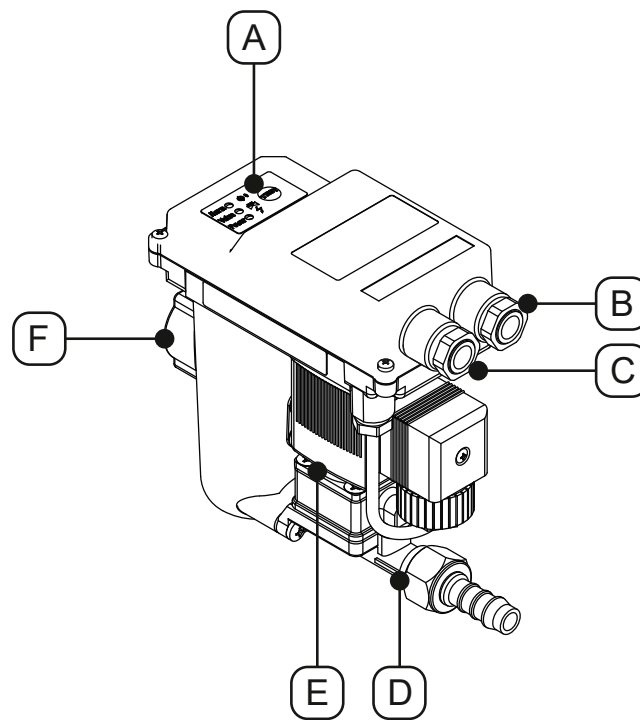


### 3.2 Exploded view BEKOMAT® 12i CO PN63

Item	Description / explanation	Item	Description / explanation
[1]	Top cover	[27]	Plug
[2]	Screw M3 x 10	[28]	Sensor tube
[3]	Dust protection pane	[29]	O-ring 31.42 x 2.62 mm
[4]	Sealing ring PG9	[30]	Fixing screw
[5]	Clamp cage PG9	[31]	O-ring 34.59 x 2.62 mm
[6]	Pressure screw PG9	[32]	Bottom cover
[7]	Plug	[33]	Cover mounting element
[8]	Power control board	[34]	Control circuit board
[9]	Nut M5	[35]	Screw M3 x 6
[10]	Washer	[36]	Cable clamp
[11]	Control air cover	[37]	Cord packing 2 x 315 mm
[12]	Screw M4 x 30	[38]	O-ring 5.5 x 1.5 mm
[13]	Flat gasket	[39]	Solenoid coil
[14]	Solenoid valve connector	[40]	O-ring 11.1 x 1.78 mm
[15]	Fixing screw	[41]	Screw M4 x 25
[16]	Core guide pipe	[42]	Flange
[17]	Oval ring 21.8 x 1.5 x 2.5 mm	[43]	O-ring 5 x 1.5 mm (top) O-ring 6 x 1.5 mm (bottom)
[18]	Valve core with spring	[44]	Pressure spring
[19]	Membrane cap	[45]	O-ring 9.25 x 1.78 mm
[20]	O-ring 5.5 x 1.5 mm	[46]	O-ring 4 x 1.5 mm
[21]	Membrane	[47]	Earthing screw
[22]	Screw M4 x 12	[48]	Pressure screw PG7
[23]	-	[49]	Pressure ring PG7
[24]	Plug	[50]	Sealing ring PG7
[25]	Membrane seat	[51]	Cable clamp
[26]	Housing	[52]	Screw M3 x 6



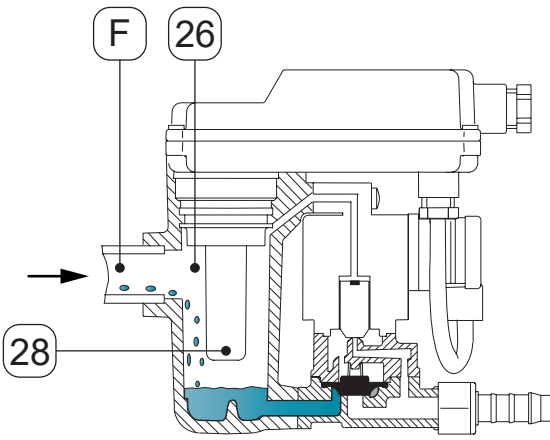
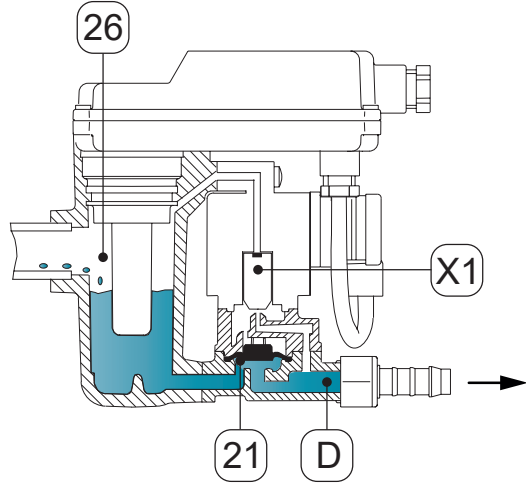
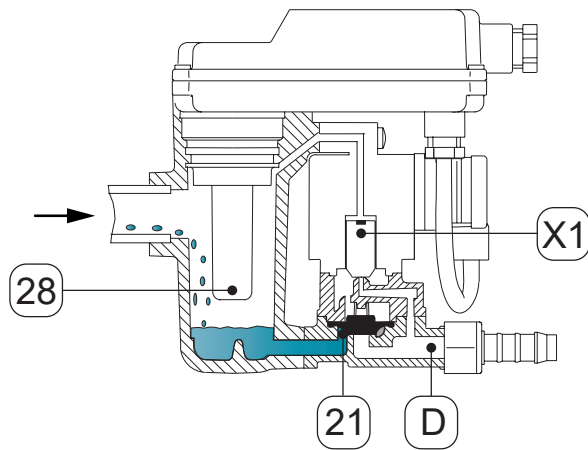
### 3.3 Product overview



Item	Description / explanation
[A]	Control panel
[B]	Right cable gland
[C]	Left cable gland

Item	Description / explanation
[D]	Condensate discharge
[E]	Valve unit
[F]	Condensate inlet

### 3.4 Function description

Illustration	Description / explanation
	<p>The condensate flows via the condensate inlet <b>[F]</b> into the <b>BEKOMAT®</b> and collects in the housing <b>[26]</b>.</p> <p>The filling level in the housing <b>[26]</b> is continuously monitored by a capacitive sensor in the sensor tube <b>[28]</b>.</p>
	<p>Once the condensate has reached the maximum fill level, the pilot valve <b>[X1]</b> is activated using the controller.</p> <p>The pilot valve <b>[X1]</b> activates, and the area above the membrane <b>[21]</b> is depressurised.</p> <p>The membrane <b>[21]</b> lifts off the valve seat and the excess pressure in the housing <b>[26]</b> presses the condensate into the condensate discharge <b>[D]</b>.</p>
	<p>When the sensor in the sensor tube <b>[28]</b> is no longer covered by condensate, the controller of the pilot valve <b>[X1]</b> activates and pressure builds up above the membrane <b>[21]</b>.</p> <p>The membrane <b>[21]</b> is pressed against the valve seat and the condensate discharge <b>[D]</b> is sealed tightly.</p> <p>The switching cycle starts again with the feed of condensate.</p>

## 3.5 Modbus function

The **BEKOMAT®** has an integrated Modbus which can be used to read out the operating parameters and device information.

The **BEKOMAT®** is operated using the client-server system with operating mode Modbus-RTU.

Data is transmitted via an RS485 interface in binary format.

### 3.5.1 Default interface parameters

The **BEKOMAT®** is available via Modbus 10 seconds after start-up with the following interface parameters.

Value	Parameter
Baud rate	19200
Data bits	8
Stop bits	1
Parity	even
Client address	247

### 3.5.2 Byte sequence

Data type	Modbus register	Division
float	2 Register	ABCD
u32	2 Register	ABCD
u16	1 Register	AB
u8	1 Register	A
u8		B

### 3.5.3 Implemented functions

The following Modbus functions are supported:

1. Read Input Registers (0x04)
2. Read Device Identification (0x2B / 0x0E)
3. Changing interface parameters



### 3.5.3.1 Read Input Registers (0x04)

Modbus address	Contents	Description / explanation	Data type
1116	Main Timer Hi-Word	Operating hours counter [h]	u32
1117	Main Timer Lo-Word		
1102	Main Counter Hi-Word	Counter for switching cycles	u32
1103	Main Counter Lo-Word		
1540	Temperature Hi-Word	CPU temperature [°C]	float
1541	Temperature Lo-Word		
1542	Temperature Hi-Word	CPU Temperature [°F]	float
1543	Temperature Lo-Word		
1544	Voltage Hi-Word	Supply Voltage [V]	float
1545	Voltage Lo-Word		
1700	Status POWER LED	LED off = 0 LED 100 % = 1 LED 50 % = 2	u16
1701	Status ERROR LED	LED off = 0 LED 100 % = 1 LED 50 % = 2	u16
1702	Status Valve LED	LED off = 0 LED 100 % = 1 LED 50 % = 2	u16
1760	Main Button State	Status TEST button On = 1 Off = 0	u16
3103	Remaining Time Hi-Word	Remaining service time [%]	float
3104	Remaining Time Lo-Word		
3105	Remaining Counts Hi-Word	Remaining switching cycles [%]	float
3106	Remaining Counts Lo-Word		
3200	Error Flags	All Error Flags Bit 1 = Error1 Flag Bit 2 = Error2 Flag Bit 3 = Error3 Flag Bit 4 = Error4 Flag Bit 5 = Error5 Flag Bit 6 = Error6 Flag	u16
3201	Error1 Flag	Code Flash faulty 1 = Error active 0 = Error inactive	u16
3202	Error2 Flag	Configuration faulty 1 = Error active 0 = Error inactive	u16
3203	Error3 Flag	Device not adjusted 1 = Error active 0 = Error inactive	u16

Modbus address	Contents	Description / explanation	Data type
3204	Error4 Flag	Hardware faulty 1 = Error active 0 = Error inactive	u16
3205	Error5 Flag	Alarm 1 = Error active 0 = Error inactive	u16
3206	Error6 Flag	Voltage supply drop during discharge 1 = Error active 0 = Error inactive	u16


### 3.5.3.2 Read Device Identification (0x2B / 0x0E)

The advanced function (MEI Type) Read Device Identification (0x2B / 0x0E), can be used to read out the following device-specific data.

Object ID	Item name (Modbus specification)	Description / explanation	Examples	Format
0x00	VendorName	Manufacturer	BEKO TECHNOLOGIES	ASCII
0x01	ProductCode	BEKO material number circuit board	4023034	ASCII
0x02	MajorMinorRevision	Software version numbers*	APP V2.3.0 BBS V3.4.0 CFG V1.0.0	ASCII
0x03	VendorUrl	BEKO website	<a href="http://www.beko-technologies.com">http://www.beko-technologies.com</a>	ASCII
0x04	ProductName	BEKO product name	BEKOMAT	ASCII
0x05	ModelName	BEKO circuit board designation	KA2C OL11 2044 ELV P i4.0	ASCII
0x06	UserApplicationName	BEKO serial number circuit board	1912720040	ASCII
0x80	n.a.	Production: Circuit board test date	03/01/2018/14:53:16/01/01/01	ASCII
0x81	n.a.	Production: Circuit board adjustment date	04/02/2018/08:25:44/01/01/01	ASCII
0x82	n.a.	Production: Circuit board calibration date	04/02/2018/08:25:44/01/01/01	ASCII
0x83	n.a.	Production: free	04/02/2018/08:25:44/01/01/01	ASCII
0x85	n.a.	BEKO material number BEKOMAT®	0004046022	ASCII
0x86	n.a.	BEKO serial number BEKOMAT®	0014345535	ASCII
0x87	n.a.	Customer material number, optional	--	ASCII

\* Legend:  
APP = application  
BBS = BEKO basic software  
CFG = Configuration

### 3.5.3.3 Changing interface parameters

INFORMATION	<b>BEKO TECHNOLOGIES configuration tools!</b>
	<p><b>BEKO TECHNOLOGIES</b> recommends using the Software Integrator to change the interface parameters. The software can be downloaded from the <b>BEKO TECHNOLOGIES</b> homepage (see “1.1 Contact” on Page 5).</p> <p>For connection to a PC, <b>BEKO TECHNOLOGIES</b> recommends using the Integrator Hardware Kit (for ordering information see chapter “11.2 Accessories” on Page 61).</p>

This process is used to change interface parameters required for communication.

1. Write the value 0xAC1D (decimal: 44061) to the Holding Register 0x1392 (decimal: 5010).
2. Write the parameter to the Holding Register 0x07D0 (decimal: 2000).

	Description / explanation
HighByte:	See the following table
LowByte:	Modbus Client address 1 ... 246
Example value:	0x070A (decimal: 1802) For interface parameters see table Index 0x07 (decimal: 7) Client address 0x0A (decimal: 10)

3. To save the settings write the value 0xBA5E (decimal: 47710) to the Holding Register 0x139C (decimal: 5020).
  4. Switch the product off and switch it back on again.
- The changes will go into effect approx. 10 seconds after the restart.

Parameter - HighByte			
Selection	Baud rate [Bd]	Parity	Stop Bit
0x00	4800	No	2
0x01	4800	Even	1
0x02	4800	Odd	1
0x03	9600	No	2
0x04	9600	Even	1
0x05	9600	Odd	1
0x06	19200	No	2
0x07	19200	Even	1
0x08	19200	Odd	1
0x09	38400	No	2
0x0A	38400	Even	1
0x0B	38400	Odd	1

Parameter - HighByte			
Selection	Baud rate [Bd]	Parity	Stop Bit
0x0C	57600	No	2
0x0D	57600	Even	1
0x0E	57600	Odd	1
0x0F	76800	No	2
0x10	76800	Even	1
0x11	76800	Odd	1
0x12	115200	No	2
0x13	115200	Even	1
0x14	115200	Odd	1

### 3.5.3.4 Control commands

The forwarding of control commands to the product is described below.

Control command	Control-Holding-Register (Modbus Specification)			Description / explanation
	Hex.	Dec.	Command Value	
Beacon on	0x1770	6000	0x0001	All the LEDs of a certain device flash at the same time to identify this device.
Beacon off	0x1770	6000	0x0000	End flashing of the LEDs.
Valve control, start	0x1771	6001	time	Start the discharge process for a given time in milliseconds. → Maximum possible duration of the entry: 65000 ms.
Valve control, end.	0x1771	6001	0x0000	Stop the discharge process.
Service interval, time	0x1772	6002	0x0001	Reset the time until the next maintenance.
Service interval, switching cycles	0x1772	6002	0x0002	Reset the switching cycles until the next maintenance.
Restart device	0x1773	6003	0x8E40	Restart the device.

- Write the value 0xBEEF (decimal: 48879) to the Key Register 0x1392 (decimal: 5010).  
→ Write access and control command function are released for 1 minute.
- Select the control command from the control command table and write it to the respective Control Holding Register.  
Example: Reset the time until the next maintenance

Register	Value
Control-Holding-Register:	0x1772 (dec. : 6002)
Command Value:	0x0001

- After the values have been entered in the Control Holding Register, the release of write access and the control command function expires.

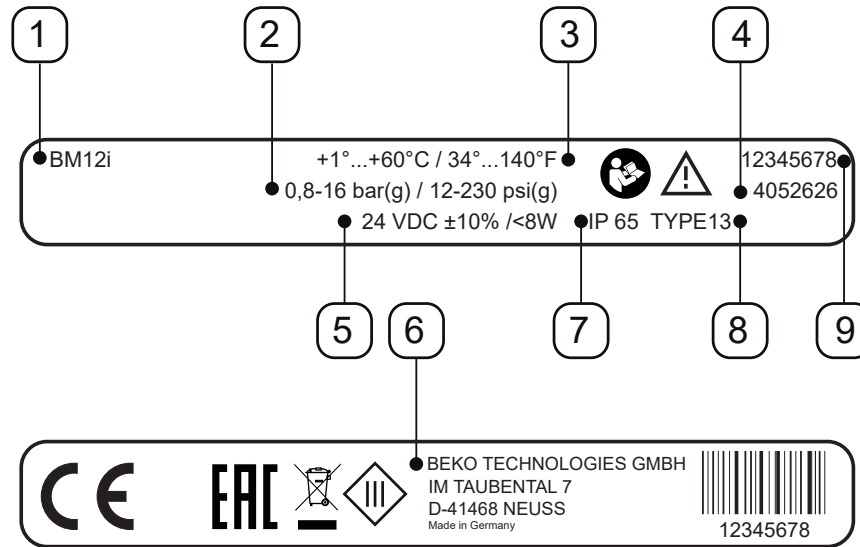
### 3.5.3.5 Error messages

Error code	Error message	Description / explanation
01	ILLEGAL FUNCTION	Function not implemented
02	ILLEGAL DATA ADDRESS	Requested address outside of the valid range
03	ILLEGAL DATA VALUE	Incorrect data
04	SERVER DEVICE FAILURE	Error occurred during inquiry that cannot be eliminated

### 3.6 Type plate

The type plate, which contains the identification information and operating parameters of the **BEKOMAT®**, is located on the housing.

If you contact the manufacturer or supplier, always have this data ready for system identification.



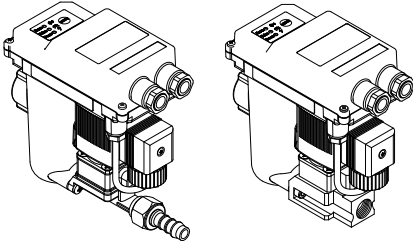

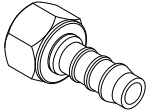
Example illustration

Item	Description / explanation
[1]	Product name
[2]	Operating pressure
[3]	Operating temperature
[4]	Material number
[5]	Operating voltage
[6]	Manufacturer
[7]	IP degree of protection
[8]	Housing class
[9]	Serial number

For more information, see “2.4 Explanation of the safety symbols used” on Page 9.

### 3.7 Scope of delivery

The table below shows the scope of delivery of the **BEKOMAT®**:

Illustration	Description / explanation
	<p><b>BEKOMAT® 12i</b> <b>BEKOMAT® 12i CO</b> <b>BEKOMAT® 12i CO PN63</b></p>
	<p>Original installation and operation manual</p>
	<p>1 x connector</p>

## 4. Technical data

### 4.1 Operating parameters

BEKOMAT®	12i	12i CO	12i CO PN63
Ambient relative humidity	10 ... 80 %, without condensation		
Maximum operating height	2000 m 2187.23 yd		
Minimum / maximum operating pressure	0.8 ... 16 bar(g) 12 ... 230 psi(g)		1.2 ... 63 bar(g) 18 ... 913 psi(g)
Minimum / maximum operating temperature	+1 ... +60 °C +34 ... +140 °F		
Average discharge rate	1.43 l/h 0.37 gal/h		
Maximum discharge rate (short-term)	30 l/h 2.64 gal/h		
Connection*, Condensate inlet	1 x G1/2, internal maximum screw-in depth: 13.5 mm (1/2 in)		
Connection, condensate discharge	1 x G3/8 external, hose connection for hose diameter 10 ...13 mm (0.39 ... 0.51 in), internal		1 x G3/8 internal
Media	Condensate, oil- contaminated	Condensate, oil-contaminated or oil-free	
Empty weight	0.8 kg 1.8 lbs		0.9 kg 2.0 lbs
Operating voltage	24 VDC ±10% (see type plate)		
Power consumption	P <8.0 VA (W)		
Degree of protection	IP65		
Housing class (UL50E)	TYPE 13		
Overvoltage category (IEC 61010-1)	III		
Degree of pollution (IEC 61010-1)	3		
Recommended cable diameter	5 ... 10 mm 0.23 ... 0.33 in		
Recommended wire cross-section	0.25 ... 1 mm <sup>2</sup> AWG 18 ... 24		
Recommended shortening of the cable jacket	~ 50 mm ~ 1.97 in		
Recommended stripping length of the cable wires	~ 6 mm ~ 0.24 in		

\* The NPT thread version is optional.

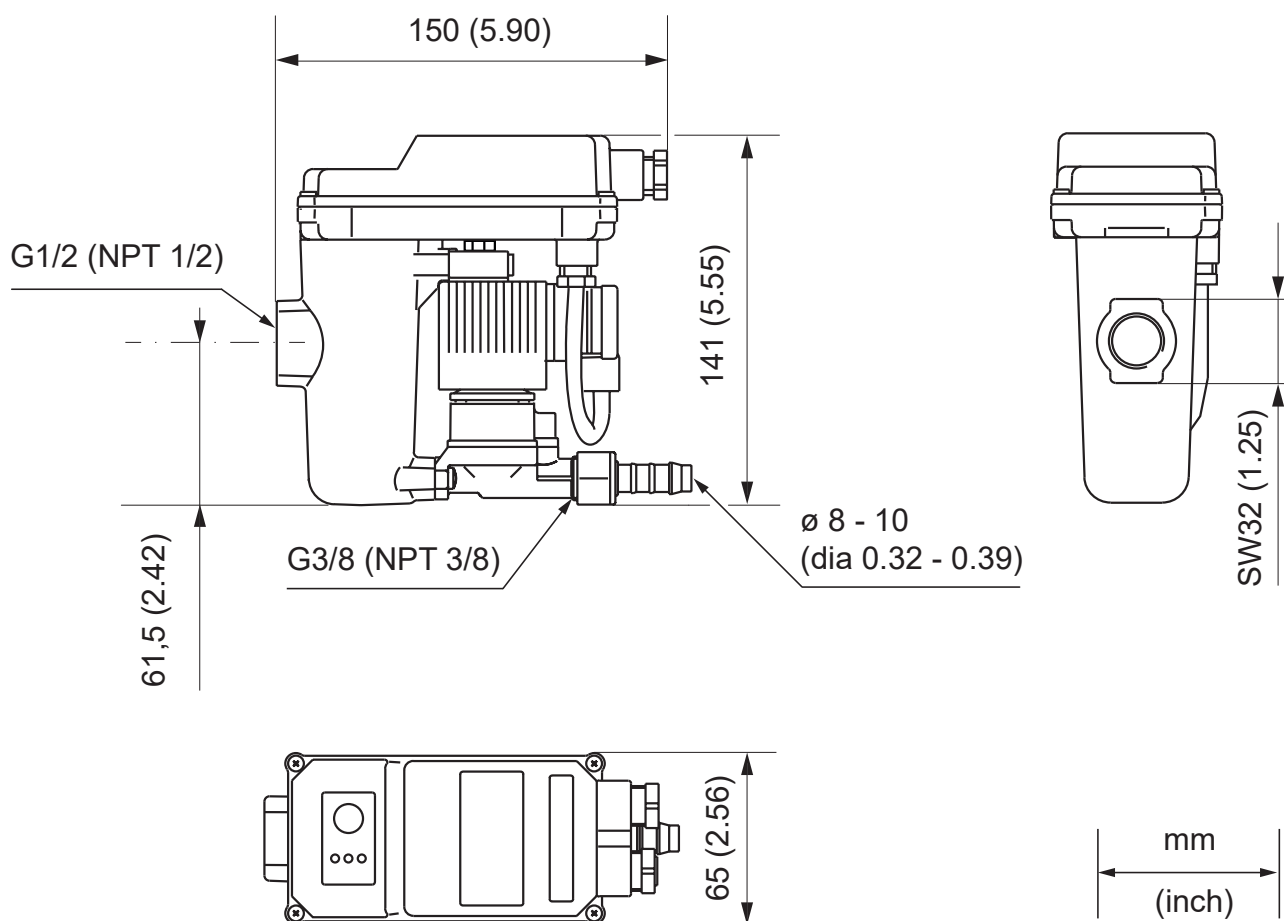
### 4.2 Storage and transportation parameters

BEKOMAT®	12i	12i CO	12i CO PN63
Minimum / maximum temperature, storage and transportation		+1 ... +60 °C +34 ... +140 °F	

### 4.3 Materials

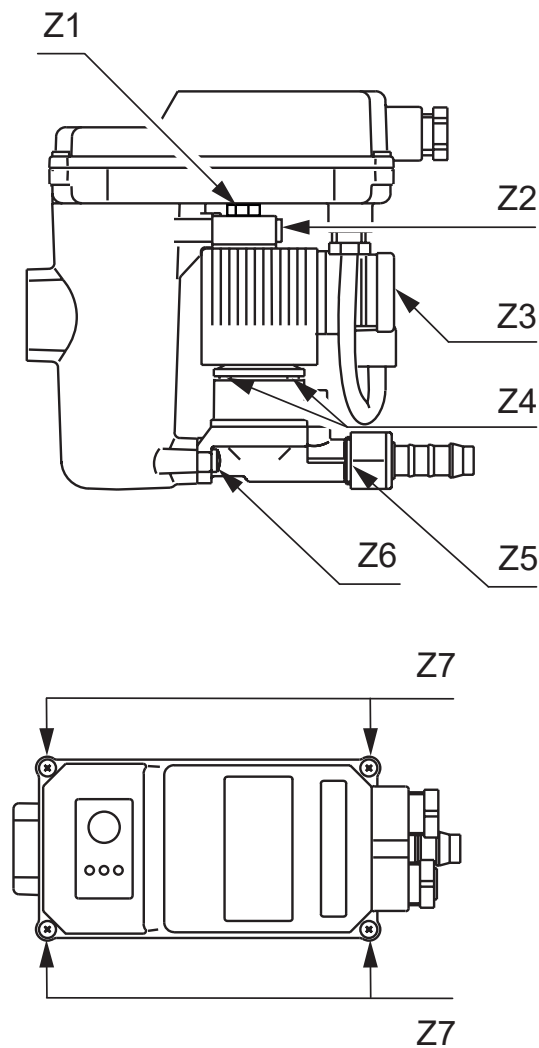
BEKOMAT®	12i	12i CO	12i CO PN63
Housing	Aluminium	Aluminium hardcoated	
Membrane	FKM		

### 4.4 Dimensions BEKOMAT® 12i, BEKOMAT® 12i CO



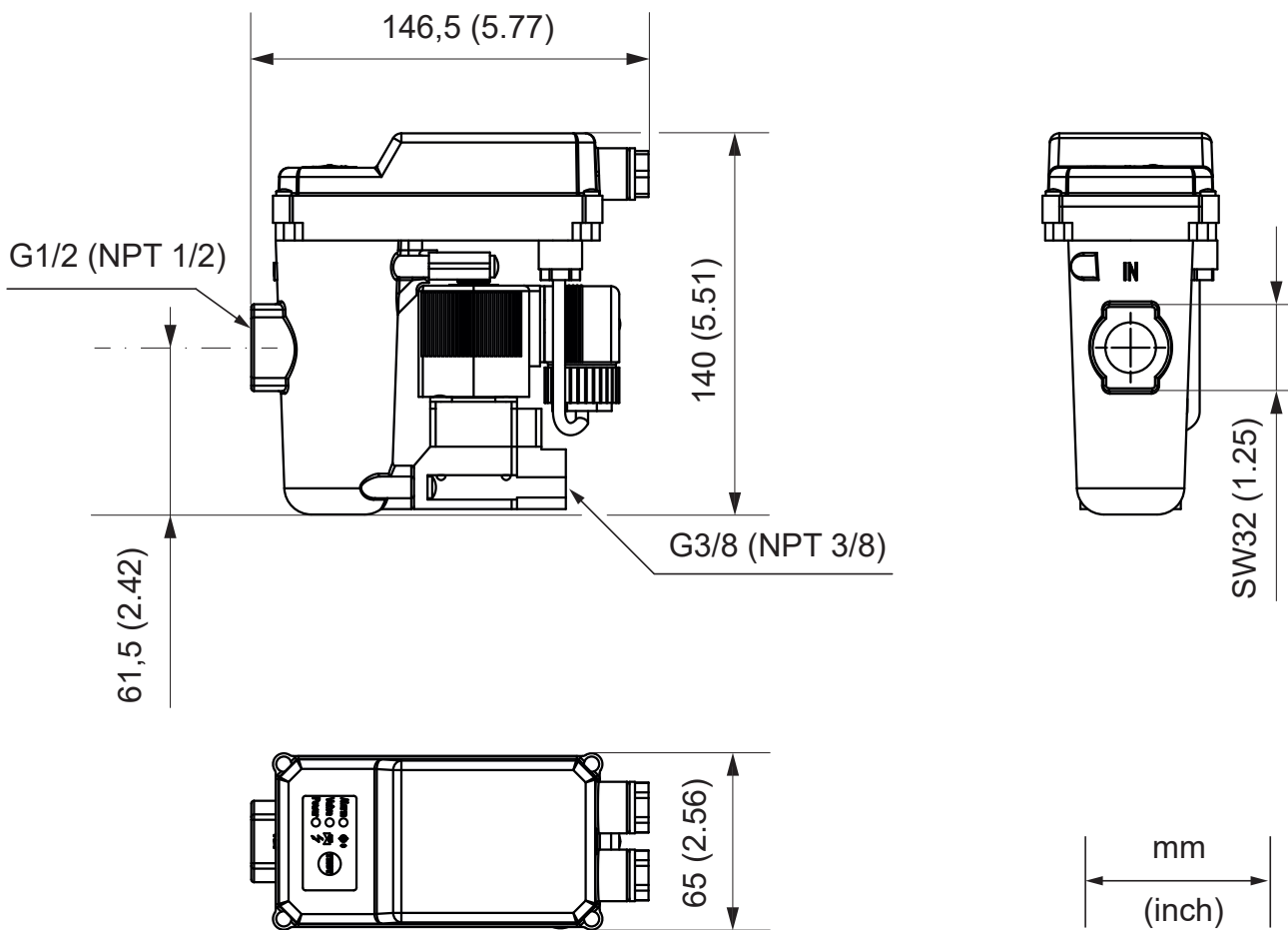


## 4.5 Screw fastening torques BEKOMAT® 12i, BEKOMAT® 12i CO

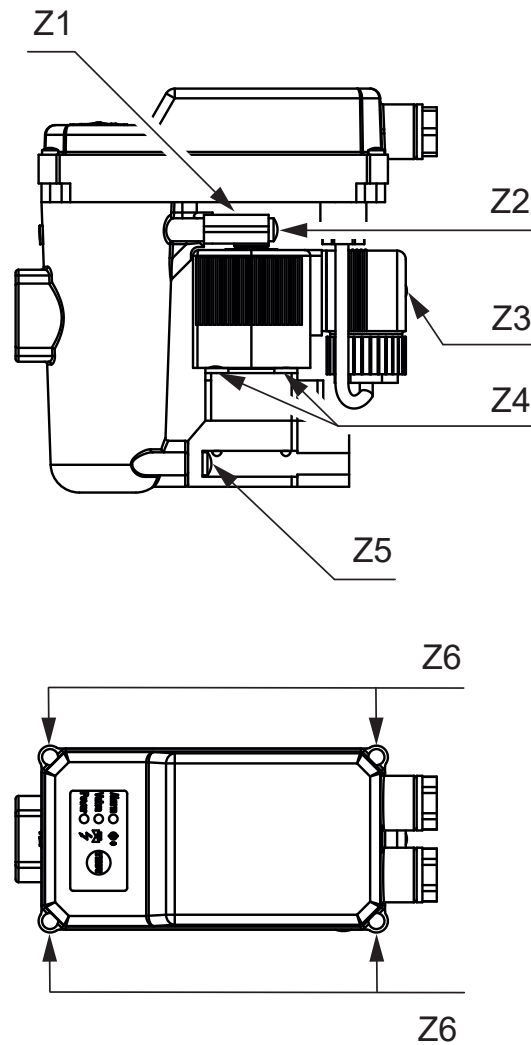


Item	Description / explanation	Fastening torques
[Z1]	Nut, control-air cover	2 Nm +0.5 Nm (1.48 ft-lb +0.37 ft-lb)
[Z2]	Screws, control-air cover	1.5 Nm +0.5 Nm (1.11 ft-lb +0.37 ft-lb)
[Z3]	Screw, solenoid valve connector	1 Nm +0.2 Nm (0.74 ft-lb +0.15 ft-lb)
[Z4]	Screws, membrane cap valve unit	1.5 Nm +0.5 Nm (1.11 ft-lb +0.37 ft-lb)
[Z5]	Hose connection, condensate discharge	3 ... 4 Nm (2.21 ... 2.95 ft-lb)
[Z6]	Screws, valve unit	1.5 Nm +0.5 Nm (1.11 ft-lb +0.37 ft-lb)
[Z7]	Screws, top cover	0.5 Nm +0.5 Nm (0.37 ft-lb +0.37 ft-lb)

### 4.6 Dimensions BEKOMAT® 12i CO PN63

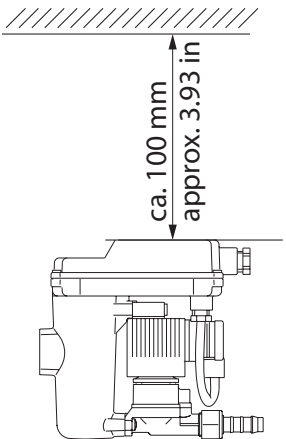


## 4.7 Screw fastening torques BEKOMAT® 12i CO PN63

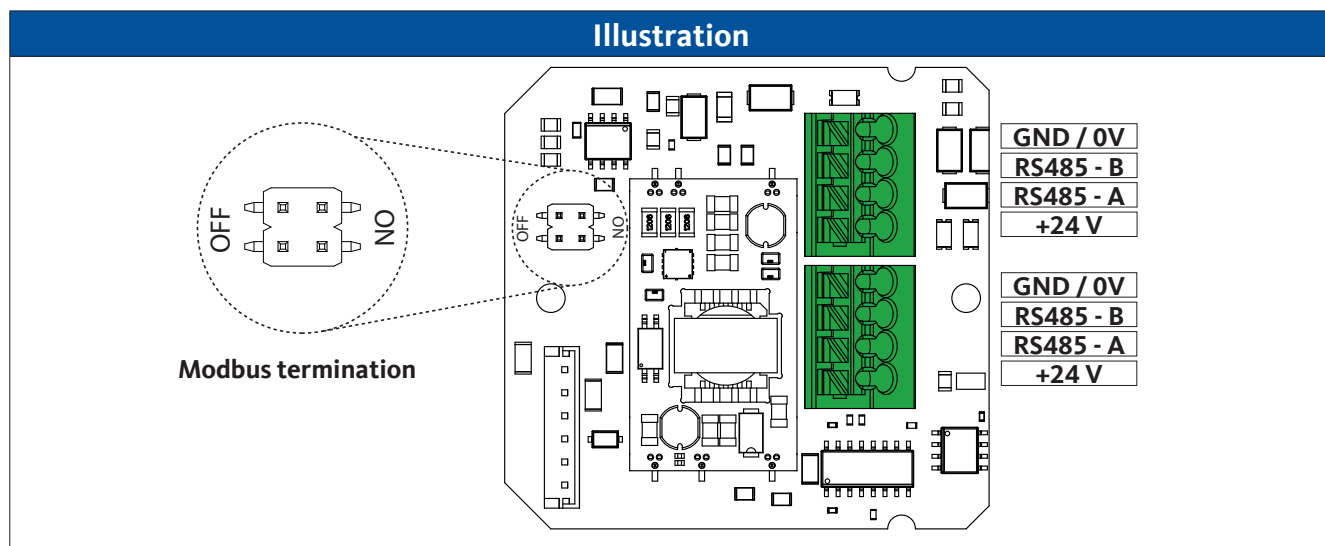


Item	Description / explanation	Fastening torques
[Z1]	Nut, control-air cover	2 Nm +0.5 Nm (1.48 ft-lb +0.37 ft-lb)
[Z2]	Screws, valve unit	1.5 Nm +0.5 Nm (1.11 ft-lb +0.37 ft-lb)
[Z3]	Screws, solenoid valve connector	1 Nm +0.2 Nm (0.74 ft-lb +0.15 ft-lb)
[Z4]	Screws, membrane cap valve unit	1.5 Nm +0.5 Nm (1.11 ft-lb +0.37 ft-lb)
[Z5]	Screws, valve unit	1.5 Nm +0.5 Nm (1.11 ft-lb +0.37 ft-lb)
[Z6]	Screws, top cover	0.5 Nm +0.5 Nm (0.37 ft-lb +0.37 ft-lb)





### 4.8 Installation dimensions

Illustration	Description / explanation
	<p>Allow sufficient assembly space above the top cover at the place of installation so that the LEDs are visible and the TEST button can be pressed.</p>

### 4.9 Terminal diagram power control board



## 5. Transport and storage

<b>WARNING</b>	<b>Insufficient qualification!</b>
	<p>Insufficient qualification of the personnel carrying out work on the product and accessories can lead to accidents, personal injury and damage to property as well as impair operation.</p> <ul style="list-style-type: none"> <li>The work on the product and accessories described below may only be executed and documented by skilled personnel - transport and storage.</li> </ul>
<b>CAUTION</b>	<b>Inappropriate transport or storage!</b>
 	<p>Inappropriate transport or storage may result in personal injury or damage to the device.</p> <ul style="list-style-type: none"> <li>Use personal protective equipment during all work with packaging material.</li> <li>Handle packaging, the product and accessories carefully.</li> <li>Pack all parts impact-proof using suitable material.</li> <li>Transport and handle the packaging according to the markings (note lifting gear attachment points, the centre of gravity and alignment e.g. keep vertical, do not throw etc.).</li> <li>Only use proper means of transport and lifting equipment that is in proper working order.</li> <li>Always adhere to the permissible transport and storage parameters.</li> <li>Store the product and accessories only outside of areas exposed to direct sunlight and heat sources.</li> </ul>
<b>NOTE</b>	<b>Handling packaging material!</b>
	<p>Inappropriate disposal of packaging materials can cause environmental damage.</p> <ul style="list-style-type: none"> <li>Dispose of the packaging material in accordance with the applicable legal requirements and provisions of the country and place of use.</li> </ul>

### 5.1 Transport

After transporting and removing the packaging material, inspect the product for possible transport damage. If you find such damage, notify the carrier company, **BEKO TECHNOLOGIES** or one of its agents immediately.

Transport the product as follows:

- Only transport the product in its original packaging.
- Handle packaging and the product with care.
- Note the transport weight specification and marking on the packaging.
- Secure the packaging and the product against slipping and falling during transport.





### 5.2 Storage

Store the product and the accessories as follows:

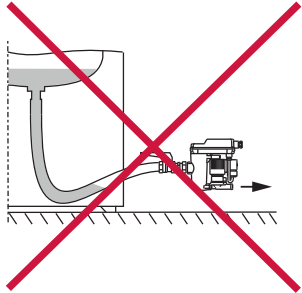
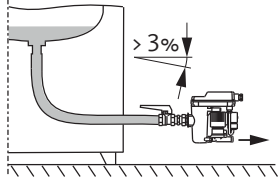
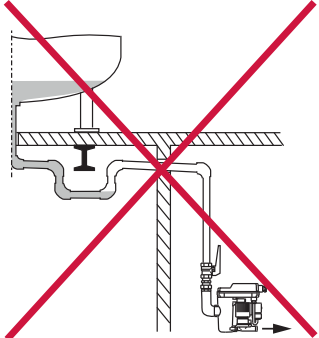
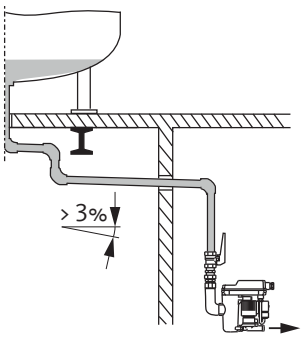
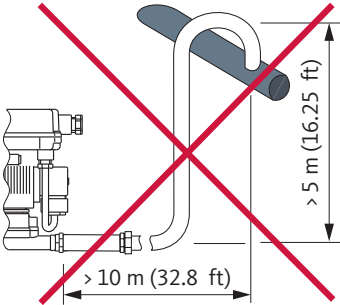
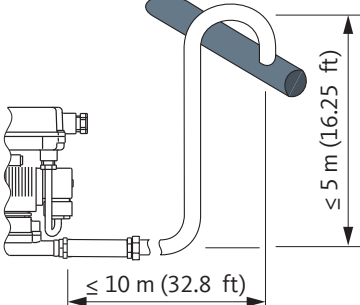
- Adhere to the storage parameters in chapter “4.2 Storage and transportation parameters” on Page 28.
- Store in a closed, dry as well as frost-free room.
- Store protected from external influences of the weather, direct sunlight and sources of heat.
- Secure against falling over and protect against vibrations at the storage location.

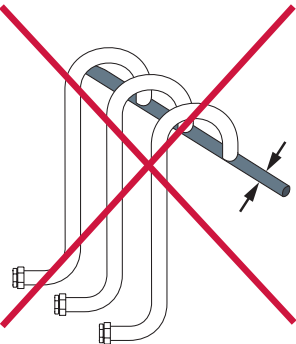
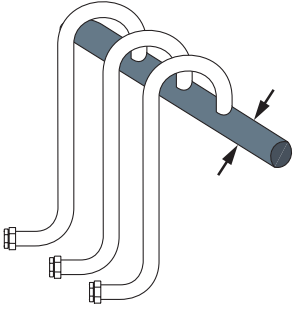
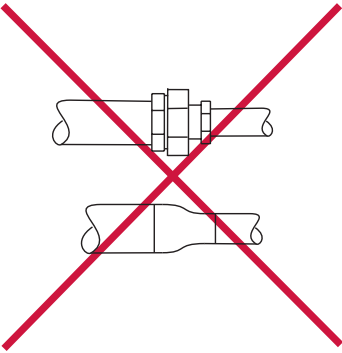
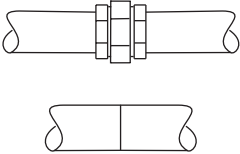
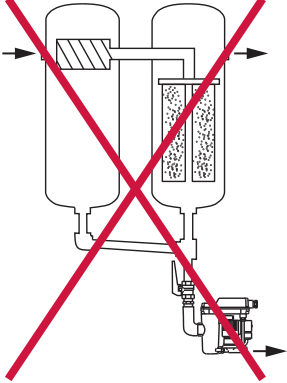
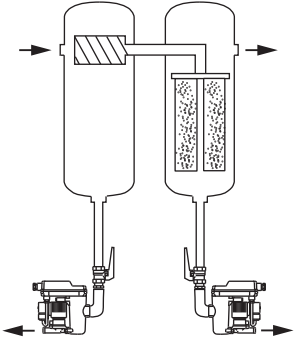
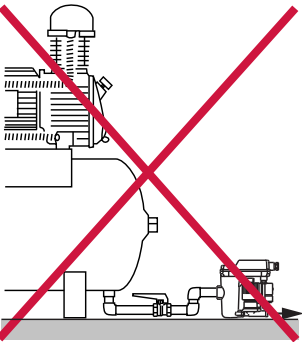
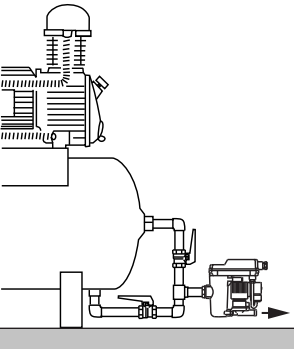
## 6. Assembly

### 6.1 Warning notices

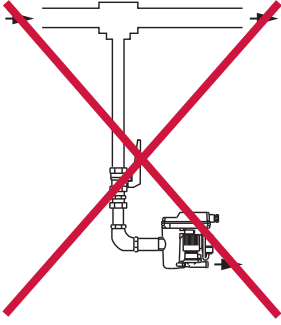
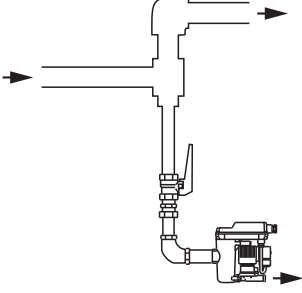
<b>DANGER</b>	<b>Use of incorrect spare parts, accessories or materials!</b>
	<p>The use of incorrect spare parts, accessories or materials, as well as auxiliary and operating materials, may result in death or serious injury. Malfunction and device failure as well as material damage can occur.</p> <ul style="list-style-type: none"> <li>• Only use undamaged original parts, auxiliary and operating materials which are specified by the manufacturer to complete all work.</li> <li>• Only use the materials approved for the respective application and suitable tools in proper working order.</li> <li>• Only use pipes that are free of dirt, damage and corrosion.</li> </ul>
<b>DANGER</b>	<b>Pressurised system!</b>
	<p>There is a danger of death or serious personal injury resulting from contact with fast or suddenly escaping fluids or through bursting system parts.</p> <ul style="list-style-type: none"> <li>• Before starting work, depressurise the pressurised system and secure it against unintentional pressurisation.</li> <li>• Set up a safety area around the working area during assembly, installation, maintenance and repair work.</li> <li>• Before pressurisation, check all system pipe connections for leak tightness and tighten if necessary.</li> <li>• Slowly pressurise the system.</li> <li>• Avoid pressure blows and high differential pressures.</li> <li>• Assemble all pipes free of mechanical stress.</li> <li>• Install the feed lines and drain lines as fixed pipes.</li> </ul>
<b>WARNING</b>	<b>Insufficient qualification!</b>
	<p>Insufficient qualification of the personnel carrying out work on the product and accessories can lead to accidents, personal injury and damage to property as well as impair operation.</p> <ul style="list-style-type: none"> <li>• All work on the product and accessories may only be carried out by skilled technical personnel - compressed gas technology.</li> </ul>
<b>CAUTION</b>	<b>Inappropriate assembly!</b>
	<p>Inappropriate assembly of the product and the accessories can lead to personal injury and damage to property as well as impair operation.</p> <ul style="list-style-type: none"> <li>• Install the product, the accessories, and all parts and materials used so that they are not subject to mechanical tension.</li> <li>• Fix hoses in such a way that they do not flap around.</li> </ul>

## 6.2 Assembly conditions

Wrong	Right	Description / explanation
		<p><b>Continuous slope &gt;3 % in hoses</b></p> <ul style="list-style-type: none"> <li>When using hoses as the feed line, ensure a continuous slope &gt;3 %.</li> <li>Do not form water pockets.</li> </ul>
		<p><b>Continuous slope &gt;3 % in pipes</b></p> <ul style="list-style-type: none"> <li>When installing the feed line pipe, ensure a continuous slope &gt;3 %.</li> <li>Do not form water pockets.</li> </ul>
		<p><b>Drain line version</b></p> <ul style="list-style-type: none"> <li>Do not use shut-off valves in the drain line.</li> <li>Only connect the <b>BEKOMAT®</b> to the drain line using a hose. <ul style="list-style-type: none"> <li>→ The hose compensates for assembly tolerances, vibrations and thermal expansion.</li> </ul> </li> <li>Do not install the drain line on storage or transportation surfaces.</li> <li>The drain line may be a maximum of 10 m (32.8 ft) long and installed at a maximum of 5 m (16.25 ft) rise. <ul style="list-style-type: none"> <li>→ The minimum operating pressure increases by 0.1 bar(g) (1.5 psi(g)) per metre of incline.</li> </ul> </li> </ul>


Wrong	Right	Description / explanation
		<p><b>Manifold design</b></p> <ul style="list-style-type: none"> <li>The cross-section of the manifold must be at least equal to the sum of the individual cross-sections of the connected feed lines.</li> <li>Lay the manifold with a continuous slope &gt;3 %.</li> </ul>
		<p><b>Diameters of the connected lines</b></p> <ul style="list-style-type: none"> <li>The minimum diameter of the feed line and the drain line must be at least 1/2" (interior diameter at least 13 mm (0.5 in)).</li> <li>Do not fit any reductions in the line (e.g. using reducing nipples or fittings).</li> </ul>
		<p><b>Bypassing filters</b></p> <ul style="list-style-type: none"> <li>Discharge each condensate collection point with a separate <b>BEKOMAT®</b>.</li> <li>Do not create any filter bypass points.</li> </ul>
		<p><b>Ensure venting</b></p> <ul style="list-style-type: none"> <li>If the slope in the inflow is not sufficient or there are other problems with the inflow, install a venting line.</li> </ul>



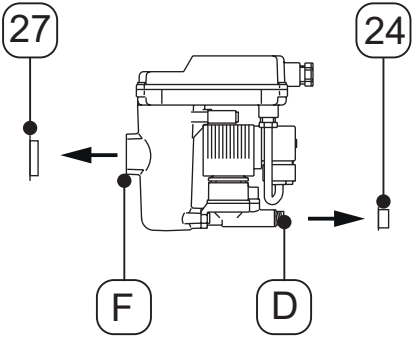
Wrong	Right	Description / explanation
		<p><b>Discharge from pressurised pipes</b></p> <ul style="list-style-type: none"> <li>Divert the flow of gas to provide a deflecting surface to discharge the fluid components in the gas.</li> </ul>

### 6.3 Assembly work

For assembly work to be carried out, the following prerequisites must be fulfilled and the preparatory tasks must have been completed.

Prerequisites		
Tools	Material	Protective equipment
<ul style="list-style-type: none"> <li>Spanner or adjustable end wrench</li> </ul>	<ul style="list-style-type: none"> <li>Sealants e.g. PTFE</li> <li>Feed line</li> <li>Drain line</li> <li>Hose, interior diameter 8 ... 10 mm (0.31 ... 0.39 in), length approx. 30 cm (1 ft)</li> <li>Hose clamp</li> </ul>	<p>Always to be worn:</p> 

Preparatory tasks	
1.	Depressurise the pressurised system or the respective system section and secure it against unintentional pressurisation.
2.	Get the hose and hose clamp ready for connection to the condensate discharge.






Assembly work	
Illustration	Description / explanation
	<ol style="list-style-type: none"> <li>Remove the plugs [24, 27] on the inlet connection [F] and drain connection [D].</li> </ol>


## Assembly work

Illustration	Description / explanation
<p>The diagram shows a side view of the BEKOMAT unit. A hose connection labeled [23] is being inserted into a port labeled [D]. An arrow points to the connection point.</p>	<ol style="list-style-type: none"> <li>Screw the enclosed hose connection [23] to the condensate discharge [D].</li> <li>Tighten the hose connection [23] with a torque of 3 ... 4 Nm (2.21 ... 2.95 ft-lb).</li> </ol>
<p>The diagram shows the BEKOMAT unit with a horizontal pipe labeled [X2] connected to the inlet port labeled [F]. A shut-off valve labeled [X3] is being installed on the pipe [X2].</p>	<p><b>Recommendation:</b> To ensure easy maintenance of the product, install a shut-off valve [X3] in the condensate inlet line [X2].</p> <ol style="list-style-type: none"> <li>For the condensate inlet line [X2], apply sealant to the end of a pressure-resistant pipe and screw this in at condensate inlet [F].</li> </ol>
<p>The diagram shows the BEKOMAT unit with a hose labeled [X4] connected to the hose connection [23]. The other end of the hose, labeled [X5], is connected to a condensate discharge line.</p>	<ol style="list-style-type: none"> <li>For the condensate discharge, push the hose provided [X4] onto the hose connection [23] and use a hose clamp for fixation.</li> <li>Connect the other end of the hose [X4] with the condensate discharge line [X5].</li> </ol>

## 7. Electrical installation



### 7.1 Warning notices

<b>DANGER</b>	<b>Use of incorrect spare parts, accessories or materials!</b>
	<p>The use of incorrect spare parts, accessories or materials, as well as auxiliary and operating materials, may result in death or serious injury. Malfunction and device failure as well as material damage can occur.</p> <ul style="list-style-type: none"> <li>• Only use undamaged original parts, auxiliary and operating materials which are specified by the manufacturer to complete all work.</li> <li>• Only use the materials approved for the respective application and suitable tools in proper working order.</li> <li>• Only use electric components and materials that comply with regionally applicable specifications and regulations for electrical safety.</li> </ul>
<b>DANGER</b>	<b>Electric voltage!</b>
	<p>There is a danger of death or serious injuries as well as malfunction and device failure following contact with components which are in contact with electric voltage.</p> <ul style="list-style-type: none"> <li>• Only carry out installation, maintenance and repair work on the product and accessories when they have been disconnected and secured against being switched back on again unintentionally.</li> <li>• Set up a safety area around the working area during all installation and repair work.</li> <li>• Adhere to all applicable regulations (e.g. VDE 0100 / IEC 60364 / ATEX) during installation.</li> <li>• Connect the protective conductor (earth connection) according to regulations.</li> </ul>
<b>WARNING</b>	<b>Insufficient qualification!</b>
	<p>Insufficient qualification of the personnel carrying out work on the product and accessories can lead to accidents, personal injury and damage to property as well as impair operation.</p> <ul style="list-style-type: none"> <li>• All work on the product and the accessories may only be carried out by skilled technical personnel - electrical engineering.</li> </ul>
<b>CAUTION</b>	<b>Inappropriate electrical installation!</b>
	<p>Inappropriate electrical installation of the product and the accessories can lead to personal injury and damage to property as well as impair operation.</p> <ul style="list-style-type: none"> <li>• Check all plug-type connections for a correct fit.</li> <li>• Avoid stumbling hazard through appropriate cable routing.</li> <li>• Avoid mechanical strain on the cables.</li> </ul>
<b>NOTE</b>	<b>Current supply overload!</b>
	<p>Connecting multiple Modbus-capable devices to one Modbus client (such as a data logger) can cause the total connected power to exceed the maximum permitted connection power for the Modbus client.</p> <ul style="list-style-type: none"> <li>• Choose a Modbus client with sufficient connection power.</li> <li>• Use a separate current supply for the Modbus server devices if there is no Modbus server with sufficient connection power available.</li> </ul>

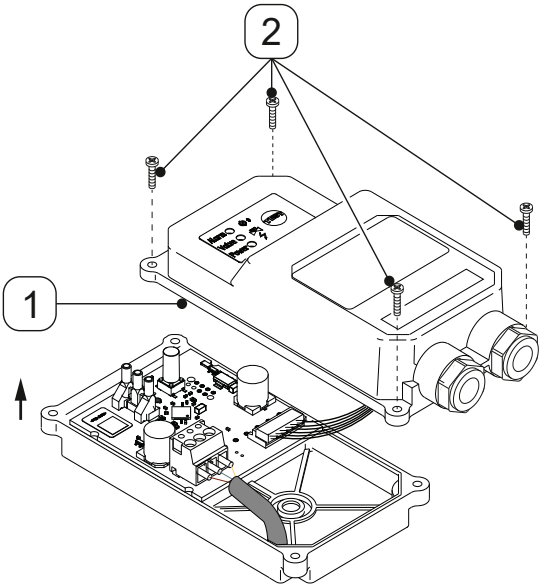
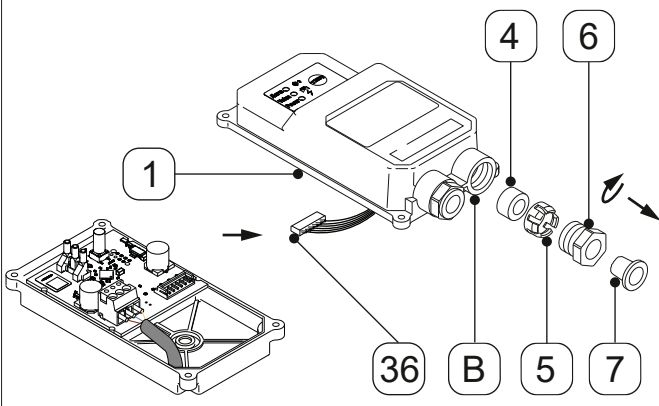
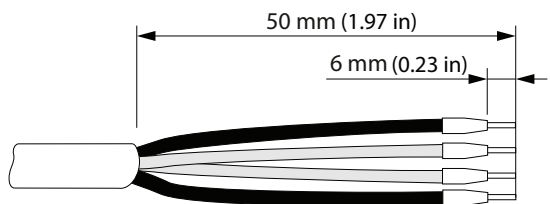
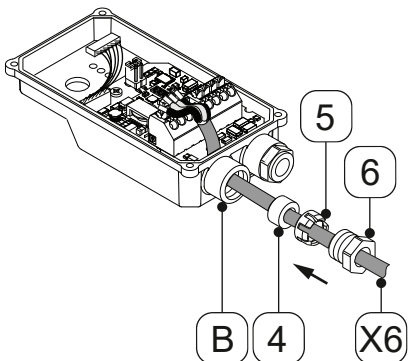
<b>NOTE</b>	<b>Electromagnetic interference!</b>
	<p>Electromagnetic faults caused by high-voltage cables, switchgears and high-frequency switching components, in particular speed-controlled and frequency-controlled drives (VSD/ VFD) can interfere with the operation of electronic devices and communication between electronic devices.</p> <ul style="list-style-type: none"> <li>• Mount electronic devices far away from high voltage cables, switching systems and high-frequency switching components.</li> <li>• Install high voltage cables, earthing cables and signal cables in separate cable ducts.</li> <li>• Always install earthing cables and signal cables at a right angle (90°) over high voltage cables.</li> <li>• Only use shielded connection cables for signal transmission.</li> <li>• Connect the shielding of the connection cables at least to the ground potential or shielding connection of the Modbus server device.</li> </ul>

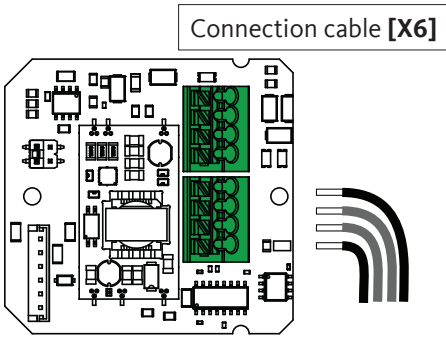
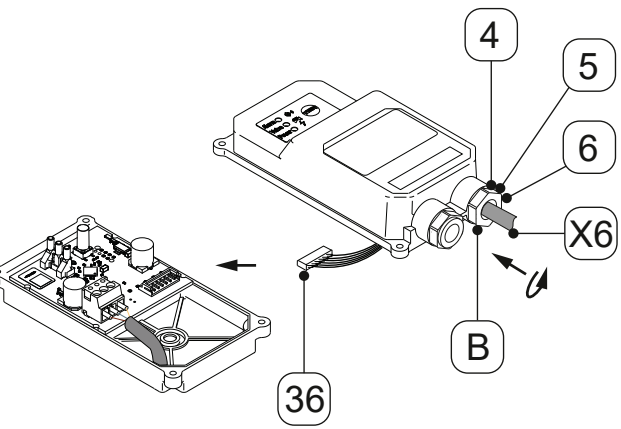
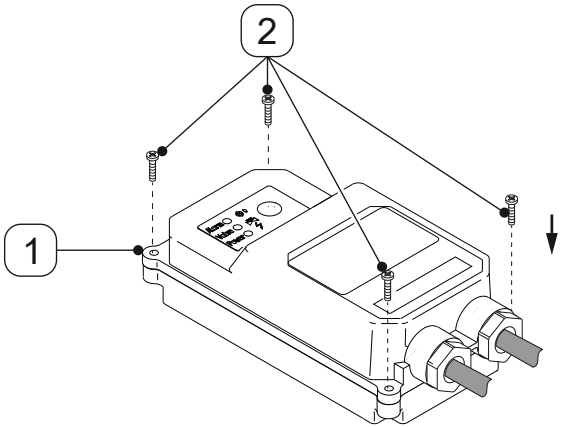
## 7.2 Connection work

For connection work to be carried out, the following prerequisites must be fulfilled and the preparatory tasks must have been completed.

<b>Prerequisites</b>		
<b>Tools</b>	<b>Material</b>	<b>Protective equipment</b>
<ul style="list-style-type: none"> <li>• Stripping tool</li> <li>• Crimping tool for wire-end ferrules</li> <li>• Screwdriver - cross-head size PZ2</li> <li>• Screwdriver – flat head size 2.5 mm (0.09")</li> </ul>	<ul style="list-style-type: none"> <li>• 4-wire shielded connection cable: 2 wires for current supply, 2 wires for Modbus</li> <li>• Wire-end ferrules</li> </ul>	<p>Always to be worn:</p> <div style="display: flex; justify-content: space-around;">   </div>
<b>Preparatory tasks</b>		
1.	Assembly is completed.	

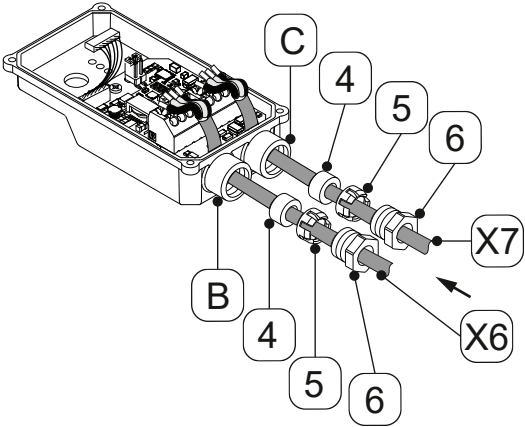
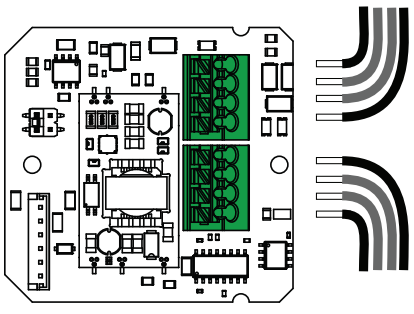
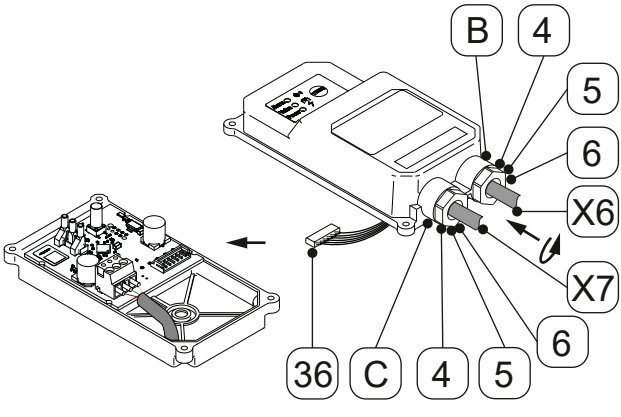
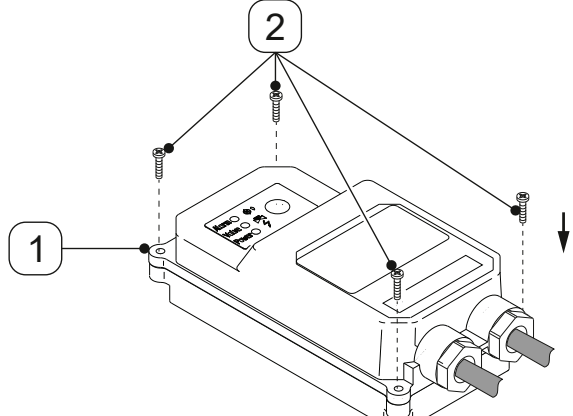
## 7.2.1 Single device connection

Connection work - single device	
Illustration	Description / explanation
	<ol style="list-style-type: none"> <li>1. Loosen the 4 screws [2].</li> <li>2. Lift the top cover [1].</li> </ol>
	<ol style="list-style-type: none"> <li>3. Raise the top cover [1] slightly and pull the terminal clamp [36] off.</li> <li>4. Remove the plug [7] and screw the cable gland components [4, 5, 6] off the right cable gland [B].</li> </ol>
	<ol style="list-style-type: none"> <li>5. Prepare the connection cable [X6].</li> </ol>
	<ol style="list-style-type: none"> <li>6. Fit the cable gland components [4, 5, 6] over the connection cable [X6].</li> <li>7. Insert the connection cable [X6] into the right cable gland [B].</li> </ol>

Connection work - single device	
Illustration	Description / explanation
 <p style="text-align: center;">Connection cable [X6]</p>	<p>8. Connect the connection cable [X6] according to the terminal diagram “4.9 Terminal diagram power control board” on Page 32.</p>
	<p>9. Screw the cable gland components [4, 5, 6] onto the right cable gland [B].</p> <p>10. Fit the screw terminal [36].</p>
	<p>11. Set the top cover [1] in place and insert the screws [2].</p> <p>12. Tighten the screws [2] with a torque of 0.5 Nm +0.5 Nm (0.37 ft-lb +0.37 ft-lb).</p>

### 7.2.2 Connecting multiple Modbus devices (series connection)





Connection work - series connection	
Illustration	Description / explanation
	<ol style="list-style-type: none"> <li>1. Loosen the 4 screws [2].</li> <li>2. Lift the top cover [1].</li> </ol>
	<ol style="list-style-type: none"> <li>3. Raise the top cover [1] slightly and pull the terminal clamp [36] off.</li> <li>4. Remove the plugs [7] and screw the cable gland components [4, 5, 6] off the right cable gland [B] and left cable gland [C].</li> <li>5. Remove the dust protection pane [3].</li> </ol>
	<ol style="list-style-type: none"> <li>6. Prepare connection cable [X6] and connection cable [X7].</li> </ol>

Connection work - series connection	
Illustration	Description / explanation
	<ol style="list-style-type: none"> <li>7. Fit the cable gland components [4, 5, 6] over the connection cable [X6] and the connection cable [X7].</li> <li>8. Insert the connection cable [X7] into the left cable gland [C].</li> <li>9. Insert the connection cable [X6] into the right cable gland [B].</li> </ol>
 <p style="text-align: center;">Connection cable [X7]</p> <p style="text-align: center;">Connection cable [X6]</p>	<ol style="list-style-type: none"> <li>10. Connect connection cable [X6] and connection cable [X7] according to the terminal diagram "4.9 Terminal diagram power control board" on Page 32.</li> </ol>
	<ol style="list-style-type: none"> <li>11. Draw cable [X6] and connection cable [X7] taut.</li> <li>12. Screw the cable gland components [4, 5, 6] onto the right cable gland [B] and the left cable gland [C].</li> <li>13. Fit the screw terminal [36].</li> </ol>
	<ol style="list-style-type: none"> <li>14. Set the top cover [1] in place and insert the screws [2].</li> <li>15. Tighten the screws [2] with a torque of 0.5 Nm +0.5 Nm (0.37 ft-lb +0.37 ft-lb).</li> </ol>

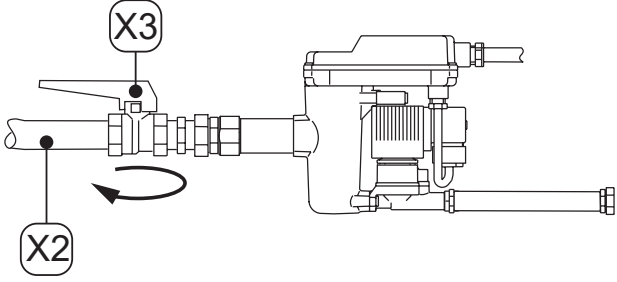
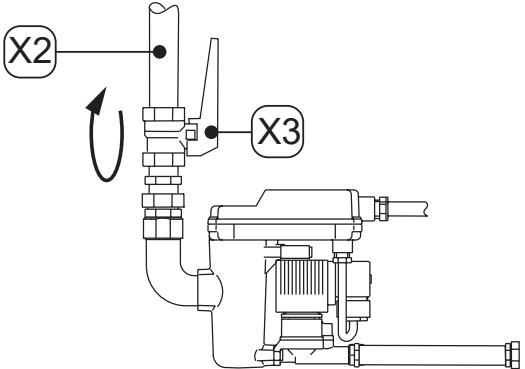


## 8. Commissioning

### 8.1 Warning notices




<b>DANGER</b>	<b>Operation outside the permissible limit range!</b>
	<p>Operation of the product and accessories outside the permissible limits and operating parameters, unauthorised intervention and modifications may result in death or serious injury.</p>
	<ul style="list-style-type: none"> <li>• Adhere to the limits and operating parameters specified on the type plate and in the manual.</li> <li>• Check whether the operating parameters have been amended or restricted by the use of accessories.</li> </ul>
<b>DANGER</b>	<b>Pressurised system!</b>
	<p>There is a danger of death or serious personal injury resulting from contact with fast or suddenly escaping fluids or through bursting system parts.</p>
	<ul style="list-style-type: none"> <li>• Before pressurisation, check all system pipe connections for leak tightness and tighten if necessary.</li> <li>• Slowly pressurise the system.</li> <li>• Avoid pressure blows and high differential pressures.</li> </ul>
<b>DANGER</b>	<b>Electric voltage!</b>
	<p>There is a danger of death or serious injuries as well as malfunction and device failure following contact with components which are in contact with electric voltage.</p>
	<ul style="list-style-type: none"> <li>• Only operate the product with the cover complete and closed or the housing closed.</li> </ul>
<b>WARNING</b>	<b>Insufficient qualification!</b>
	<p>Insufficient qualification of the personnel carrying out work on the product and accessories can lead to accidents, personal injury and damage to property as well as impair operation.</p>
	<ul style="list-style-type: none"> <li>• All work on the product and accessories may only be carried out by skilled technical personnel - compressed gas technology and skilled technical personnel - electrical engineering.</li> </ul>

## 8.2 Commissioning work

Illustration	Description / explanation
	<ol style="list-style-type: none"> <li>1. Connect the voltage supply. → The <b>BEKOMAT®</b> carries out the power-on self-test.</li> </ol>
	<ol style="list-style-type: none"> <li>2. Slowly pressurise the system (e.g. by slowly opening the recommended shut-off valve <b>[X3]</b> in the condensate inlet line <b>[X2]</b>).</li> <li>3. Carry out a functional test (see “10.3.2 Functional test” on Page 57).</li> </ol>

## 9. Operation

### 9.1 Warning notices

<b>DANGER</b>	<b>Operation outside the permissible limit range!</b>
	<p>Operation of the product and accessories outside the permissible limits and operating parameters, unauthorised intervention and modifications may result in death or serious injury.</p>
	<ul style="list-style-type: none"> <li>• Adhere to the limits and operating parameters specified on the type plate and in the manual.</li> <li>• Adhere to the assembly conditions and ambient conditions.</li> <li>• Check whether the operating parameters have been amended or restricted by the use of accessories.</li> <li>• Adhere to the maintenance intervals.</li> </ul>
<b>DANGER</b>	<b>Electric voltage!</b>
	<p>There is a danger of death or serious injuries as well as malfunction and device failure following contact with components which are in contact with electric voltage.</p>
	<ul style="list-style-type: none"> <li>• Only operate the product with the cover or housing complete and closed.</li> </ul>
<b>NOTE</b>	<b>Operating personnel!</b>
	<p>Insufficient knowledge of the product and the accessories can lead to damage to property and the environment as well as impair operation.</p>
	<ul style="list-style-type: none"> <li>• The product and accessories may only be operated and used by qualified operating personnel.</li> </ul>

## 9.2 Operating states

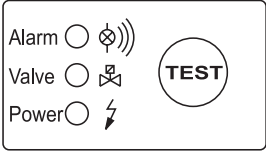
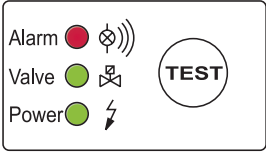
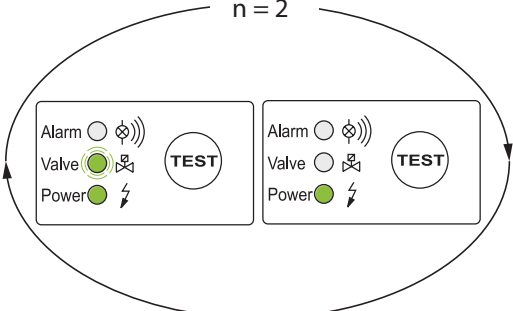
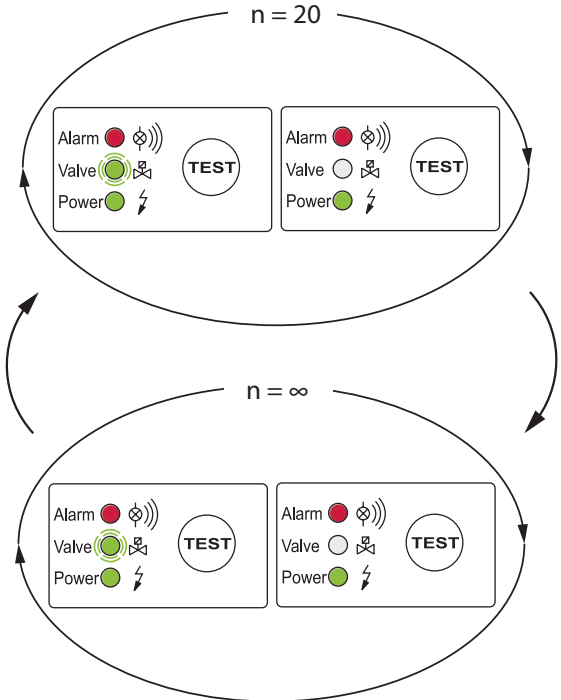
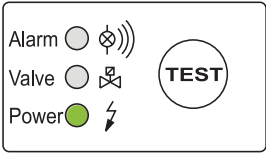
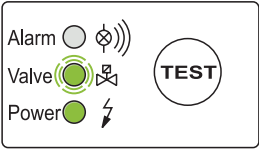
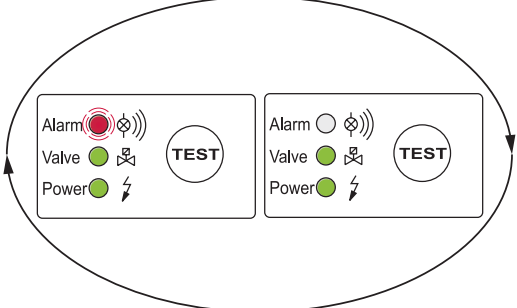
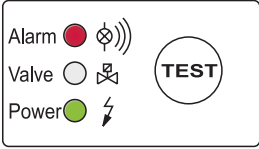
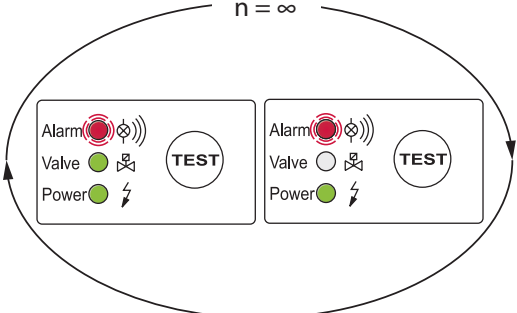




Illustration	Description / explanation
	<p><b>Disconnected</b></p> <ul style="list-style-type: none"> <li>All LEDs are off.</li> </ul>
	<p><b>Switch on / power-on self-test</b></p> <ul style="list-style-type: none"> <li>All LEDs are on for 1 second.</li> <li>The <b>BEKOMAT®</b> carries out a diagnosis of the electronics unit.</li> </ul>
	<p><b>Positive power-on self-test</b> <b>number of repetitions n = 2x</b></p> <ul style="list-style-type: none"> <li>The red ALARM LED is off.</li> <li>The green VALVE LED is on while the solenoid valve is cycling.</li> <li>The green POWER LED is on.</li> <li>The solenoid valve is cycling.</li> <li>→ The <b>BEKOMAT®</b> switches to normal operation.</li> </ul>
	<p><b>Negative power-on self-test</b> <b>number of repetitions n = 20x</b></p> <ul style="list-style-type: none"> <li>The red ALARM LED is on.</li> <li>The green VALVE LED is on while the solenoid valve is cycling.</li> <li>The green POWER LED is on.</li> <li>The solenoid valve is cycling.</li> <li>→ The <b>BEKOMAT®</b> goes into fail-safe operation (continuous loop n = ∞).</li> <li>The solenoid valve is cycling once per second.</li> </ul>
	<p><b>Ready for operation (normal operating mode)</b></p> <ul style="list-style-type: none"> <li>The red ALARM LED is off.</li> <li>The green VALVE LED is off.</li> <li>The green POWER LED is on.</li> </ul>

Illustration	Description / explanation
	<p><b>Discharge procedure (TEST button pressed briefly)</b></p> <ul style="list-style-type: none"> <li>The red ALARM LED is off.</li> <li>The green VALVE LED is on during the discharge procedure.</li> <li>The green POWER LED is on.</li> </ul>
	<p><b>Pre-alarm (TEST button pressed &gt;1 minute and &lt;5 minutes)</b></p> <ul style="list-style-type: none"> <li>The red ALARM LED flashes.</li> <li>The green VALVE LED is on.</li> <li>The green POWER LED is on.</li> </ul>
	<p><b>Alarm (TEST button pressed &gt;5 minutes)</b></p> <ul style="list-style-type: none"> <li>The red ALARM LED is on.</li> <li>The green VALVE LED is off.</li> <li>The green POWER LED is on.</li> </ul>
	<p><b>Alarm mode (malfunctioning of condensate discharge)</b></p> <ul style="list-style-type: none"> <li>The red ALARM LED flashes.</li> <li>The green POWER LED is on.</li> <li>The green VALVE LED is on when the solenoid valve is cycling. <ul style="list-style-type: none"> <li>→ The solenoid valve is cycling every 4 minutes.</li> </ul> </li> </ul> <p>After the malfunction has been eliminated, the <b>BEKOMAT®</b> automatically switches to normal operation.</p>

For further information about fault indications during operation, see “15. Troubleshooting and fault repair / FAQ” on Page 71.

## 10. Maintenance


### 10.1 Warning notices

<b>DANGER</b>	<b>Pressurised system!</b>
	<p>There is a danger of death or serious personal injury resulting from contact with fast or suddenly escaping fluids or through bursting system parts.</p>
	<ul style="list-style-type: none"> <li>• All maintenance and repair work on the system must be carried out in the depressurised state and with the system secured against unintentional pressurisation.</li> <li>• Set up a safety area around the working area during all maintenance and repair work.</li> <li>• Before pressurisation, check all system pipe connections for leak tightness and tighten if necessary.</li> <li>• Slowly pressurise the system.</li> <li>• Avoid pressure blows and high differential pressures.</li> <li>• Assemble all pipes free of mechanical stress.</li> <li>• Compensate any vibrations occurring in the pipe network by using vibration dampers.</li> <li>• Install the feed lines and drain lines as fixed pipes.</li> </ul>
<b>DANGER</b>	<b>Electric voltage!</b>
	<p>There is a danger of death or serious injuries as well as malfunction and device failure following contact with components which are in contact with electric voltage.</p>
	<ul style="list-style-type: none"> <li>• Only carry out maintenance and repair work on the product when it has been disconnected and secured against being switched back on again unintentionally.</li> <li>• Set up a safety area around the working area during all maintenance and repair work.</li> <li>• Only operate the product with the cover complete and closed or the housing closed.</li> </ul>
<b>DANGER</b>	<b>Use of incorrect spare parts, accessories or materials!</b>
	<p>The use of incorrect spare parts, accessories or materials, as well as auxiliary and operating materials, may result in death or serious injury. Malfunction and device failure as well as material damage can occur.</p>
	<ul style="list-style-type: none"> <li>• Only use undamaged original parts, auxiliary and operating materials which are specified by the manufacturer to complete all work.</li> <li>• Use only the approved materials and suitable tools for the respective purpose and make sure that they are in proper working order.</li> <li>• Only use cleaned pipes that are free of dirt and corrosion.</li> <li>• Only use electric components and materials that comply with country-specific regulations (standards, directives etc.) for electrical safety.</li> </ul>
<b>WARNING</b>	<b>Insufficient qualification!</b>
	<p>Insufficient qualification of the personnel carrying out work on the product and accessories can lead to accidents, personal injury and damage to property as well as impair operation.</p>
	<ul style="list-style-type: none"> <li>• All work on the product and the accessories may only be carried out by skilled technical personnel - customer service.</li> </ul>

## 10.2 Maintenance schedule


Maintenance	Interval
Wear part replacement	After 8760 operating hours or 1 million switching cycles*; at least annually
Cleaning	Annually
Functional test	Monthly
Visual inspection	Weekly
Leakage test	After assembly and maintenance works on the product

\* based on 7 bar(g) (101.5 psi(g)) and pH-neutral condensate

INFORMATION	Carrying out cleaning work
	Carry out cleaning work during wear part replacement since all parts are disassembled at this point.

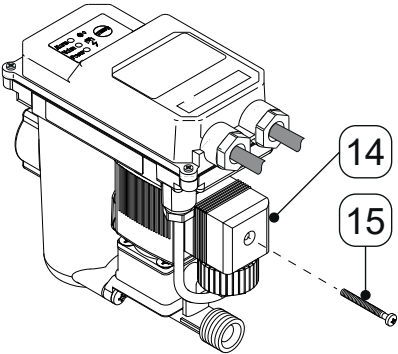
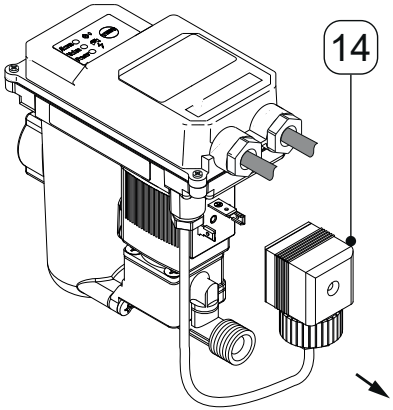
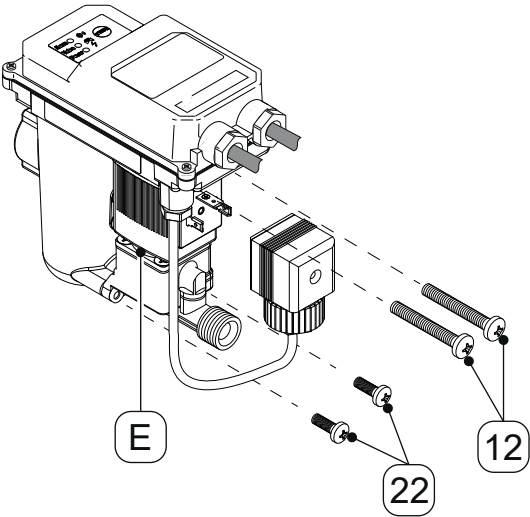
## 10.3 Maintenance work

For maintenance work to be carried out, the following prerequisites must be fulfilled and the preparatory tasks must have been completed.

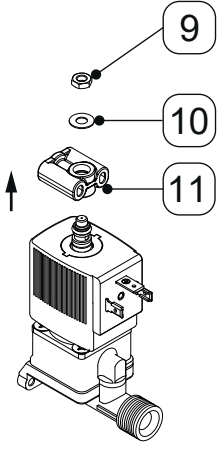
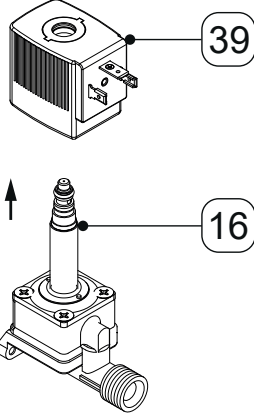
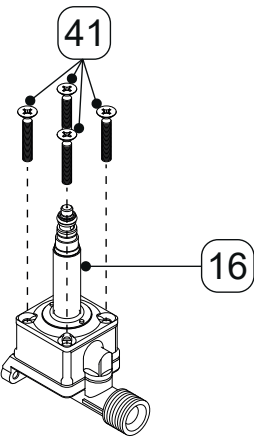
Prerequisites		
Tools	Material	Protective equipment
<ul style="list-style-type: none"> <li>Screwdriver – flat head size 2.5 mm (0.09")</li> <li>Spanner or adjustable end wrench</li> </ul>	<ul style="list-style-type: none"> <li>Sealants</li> <li>Suitable lubricant for greasing the O-rings</li> <li>Mild cleaning agent</li> <li>Cotton or disposable cloth</li> </ul>	Always to be worn: 

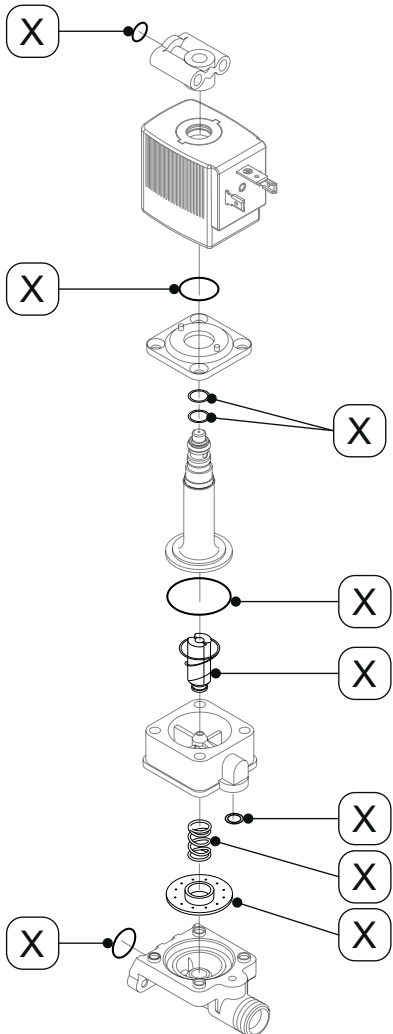
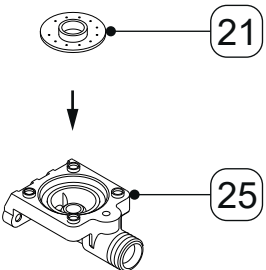
Preparatory tasks	
1.	Decommissioning and disassembly of the <b>BEKOMAT®</b> have been completed.

### 10.3.1 Wear part replacement

Wear part replacement	
Illustration	Description / explanation
	<p>1. Loosen the screw [14] of the solenoid valve connector [15].</p>
	<p>2. Pull the solenoid valve connector [14] off.</p>
	<p>3. Loosen the screws [12, 22] and take the complete valve unit [E] off.</p>



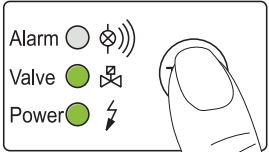
Wear part replacement	
Illustration	Description / explanation
	<p>4. Loosen the nut <b>[9]</b> and remove together with the washer <b>[10]</b> and the control-air cover <b>[11]</b>.</p>
	<p>5. Pull the solenoid coil <b>[39]</b> up and off the core guide pipe <b>[16]</b>.</p>
	<p>6. Loosen the screws <b>[41]</b> and remove the core guide pipe <b>[16]</b>.</p>

Wear part replacement	
Illustration	Description / explanation
	<p>7. Replace all the components in the set of wear parts <b>[X]</b>.</p> <p>8. Grease the O-rings in the set of wear parts.</p>
	<p>9. Place the membrane <b>[21]</b> in the membrane seat <b>[25]</b>.</p>

Wear part replacement	
Illustration	Description / explanation
<p>The diagram shows a pressure spring (44) being inserted into a membrane cap (19). An arrow points from the spring down into the cap.</p>	<p>10. Insert the pressure spring [44] in the membrane cap [19].</p>
<p>The diagram shows the membrane cap (19) being placed onto a membrane seat (25). An arrow points from the cap down to the seat.</p>	<p>11. Place the membrane cap [19] with the pressure spring [44] on the membrane seat [25]. Make sure that the pressure spring is fitted in the centre of the membrane.</p>
<p>The diagram shows the valve core assembly (41, 16, 18) being inserted into the membrane cap (19). The assembly consists of a core guide pipe (16) with a flange (42) and a spring (18). Arrows point from the assembly down into the cap.</p>	<p>12. Insert the valve core with spring [18] into the core guide pipe [16]. Guide the flange [42] with the screws [41] over the core guide pipe [16] and screw tightly on the membrane cap [19].</p> <p>13. Tighten the screws [41] with a torque of 1.5 Nm +0.5 Nm (1.11 ft-lb +0.37 ft-lb).</p>

Wear part replacement	
Illustration	Description / explanation
	<p>14. Insert the solenoid coil <b>[39]</b>, the control-air cover <b>[11]</b> and the washer <b>[10]</b> onto the core guide pipe <b>[16]</b>.</p> <p>15. Screw the nut <b>[9]</b> onto the core guide pipe <b>[16]</b> and tighten with a torque of 2 Nm +0.5 Nm (1.48 ft-lb +0.37 ft-lb).</p>
	<p>16. Attach the completed valve unit <b>[E]</b> to the housing <b>[26]</b>. Insert the screws <b>[12, 22]</b> and tighten with a torque of 1.5 Nm +0.5 Nm (1.11 ft-lb +0.37 ft-lb).</p> <p>17. Insert the solenoid valve connector <b>[14]</b> onto the solenoid coil <b>[39]</b>.</p>
	<p>18. Insert the screw <b>[15]</b> into the solenoid valve connector <b>[14]</b> and tighten with a torque of 1 Nm +0.2 Nm (0.74 ft-lb +0.15 ft-lb).</p>

### 10.3.2 Functional test

Illustration	Description / explanation
	<p>Press the TEST button for 2 ... 5 seconds.</p> <ul style="list-style-type: none"> <li>→ The red ALARM LED is off.</li> <li>→ The green VALVE LED is on.</li> <li>→ The green POWER LED is on.</li> <li>→ The valve opens and condensate is drained.</li> </ul>


### 10.3.3 Visual inspection


During the visual inspection of the **BEKOMAT®**, inspect all components for mechanical damage and corrosion. Replace damaged components immediately.



### 10.3.4 Leakage test

The leakage test is a non-destructive test method and is used to prove leak tightness in vacuum and overpressure systems. The leakage test can be carried out in different ways. **BEKO TECHNOLOGIES** provides no recommendations for selecting a testing process. The operating company of the pressurised system is responsible for the selection and specification of the test method to be used, which should be executed in corresponding to with valid standards and regulations (e.g. DIN EN 1779).

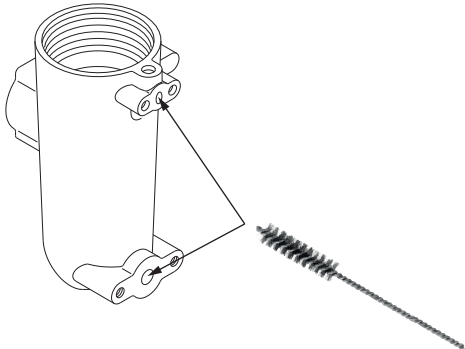
### 10.3.5 Cleaning

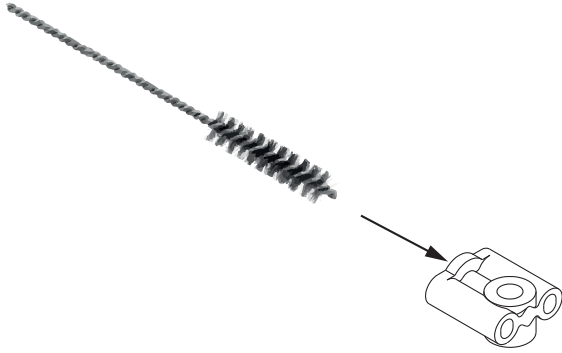
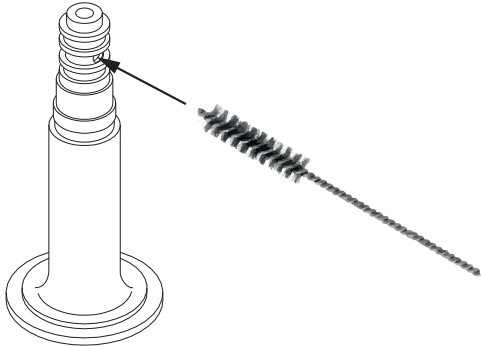
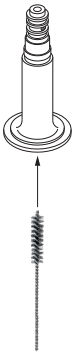
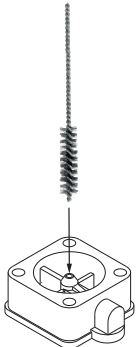
<b>CAUTION</b>	<b>Inappropriate cleaning and use of the wrong cleaning media!</b>
	<p>Inappropriate cleaning and the use of the wrong cleaning media may result in minor injuries as well as damage to health and damage to property.</p> <ul style="list-style-type: none"> <li>• Never clean the device with a dripping wet cloth.</li> <li>• Never use abrasive or aggressive cleaning agent or solvents which could damage the outer coating (e.g. markings, type plate, corrosion protection, etc.).</li> <li>• Never clean the device with hard or pointed implements.</li> <li>• Use an anti-static, damp cloth for cleaning the outside.</li> <li>• Immediately replace any product markings (pictograms, markings) that have become illegible.</li> </ul>

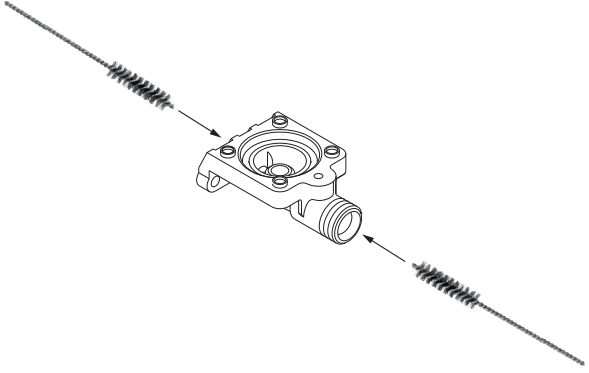
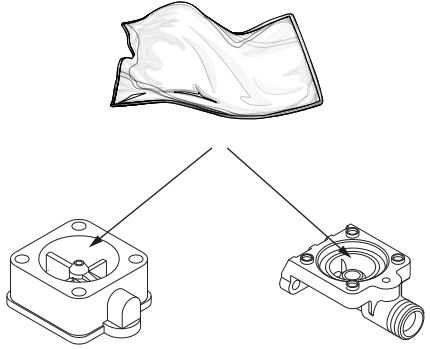
<b>NOTE</b>	<b>Local hygiene regulations!</b>
	In addition to the cleaning instructions listed, any regionally applicable hygiene regulations must be observed.

Prerequisites		
Tools	Material	Protective equipment
<ul style="list-style-type: none"> <li>• Cleaning brush</li> </ul>	<ul style="list-style-type: none"> <li>• Mild cleaning agent</li> <li>• Cotton or disposable cloth</li> </ul>	<p>Always to be worn:</p> <div style="text-align: center;">   </div>

Preparatory tasks	
1.	Decommissioning and disassembly of the <b>BEKOMAT®</b> have been completed.
2.	The <b>BEKOMAT®</b> is disassembled.

Cleaning work	
Illustration	Description / explanation
	<ol style="list-style-type: none"> <li>1. Spray mild cleaning agent onto a cotton cloth or disposable tissue until it is damp (not wet). Rub the surfaces of the <b>BEKOMAT®</b> with a damp cloth.</li> <li>2. Clean the control-air bore and the condensate discharge bore using a cleaning brush Ø max. = 2.5 mm (0.09").</li> </ol>

Cleaning work	
Illustration	Description / explanation
	3. Clean the bore in the control-air cover using a cleaning brush $\varnothing$ max. = 2.5 mm (0.09").
	4. Clean the upper opening on the core guide pipe using a cleaning brush $\varnothing$ max. = 2.5 mm (0.09").
	5. Clean the core guide pipe from below using a cleaning brush or a clean cloth.
	6. Clean the bore in the membrane cap using a cleaning brush $\varnothing$ max. = 1.5 mm (0.05").

Cleaning work	
Illustration	Description / explanation
	<p>7. Clean the bores in the membrane seat using a cleaning brush <math>\varnothing</math> max. = 2.5 mm (0.09").</p>
	<p>8. Wipe the membrane seat and the membrane cap down using a clean cloth without cleaning agent.</p>

Concluding work	
1.	Put the <b>BEKOMAT</b> ® together.
2.	Assemble the <b>BEKOMAT</b> ® (see "6. Assembly" on Page 34).
3.	Put the <b>BEKOMAT</b> ® into operation (see "8. Commissioning" on Page 45).
4.	Reset the service intervals (see "3.5.3.5 Error messages" on Page 24).



## 11. Consumables, accessories and spare parts

### 11.1 Order information

BEKO TECHNOLOGIES customer service requires the following data for an inquiry or order:

- Serial number (see type plate)
- Material number and designation of the accessory or spare part
- Required quantity of accessories or spare parts to be delivered

The contact data for the BEKO TECHNOLOGIES customer services responsible are listed in chapter “1.1 Contact” on Page 5.

### 11.2 Accessories

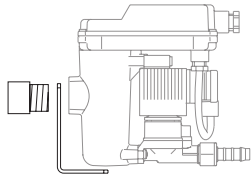
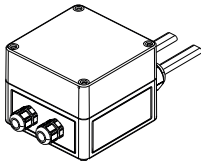
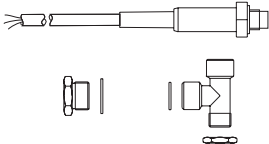
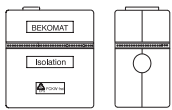
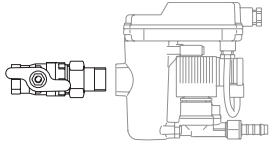
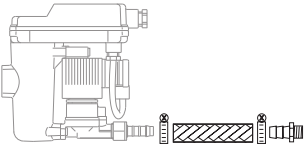
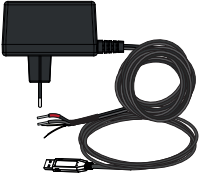

Illustration	Description	Material no.
	Mounting bracket for wall and floor  <b>BEKOMAT® 12i</b> <b>BEKOMAT® 12i CO</b>	2000035
	Trace heater 230 VAC	4041657
	Thermostatically controlled heating system <b>BEKOMAT® 12i</b> <b>BEKOMAT® 12i CO</b> 200 ... 230 VAC 100 ... 115 VAC 24 VAC/VDC	2801244 2801245 2801247
	Insulation shell	2000195
	Connection set  <b>BEKOMAT® 12i</b> <b>BEKOMAT® 12i CO</b>	2000039

Illustration	Description	Material no.
	Drain kit  <b>BEKOMAT® 12i</b> <b>BEKOMAT® 12i CO</b>	2000045
	Integrator Hardware Kit	4052710
	Software Integrator	The software can be downloaded from the BEKO TECHNOLOGIES homepage (see "1.1 Contact" on Page 5).

### 11.3 Spare parts

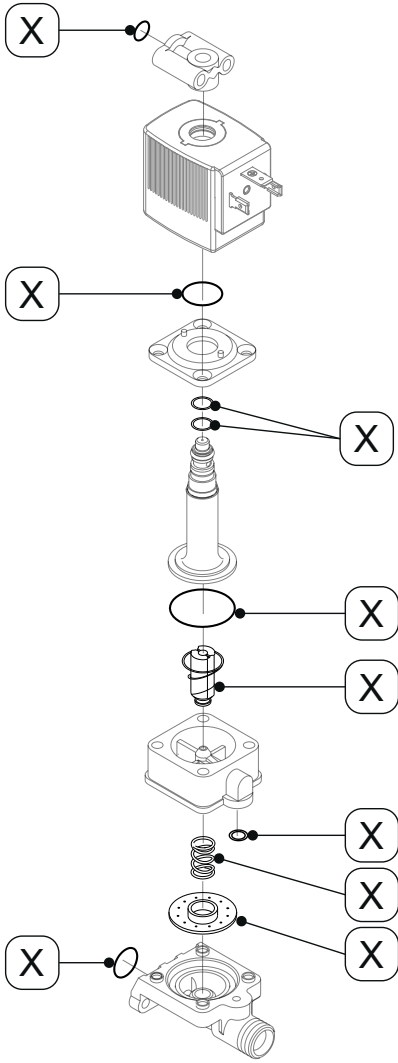
Illustration	Description	Material no.
	Set of wear parts (contains the marked components [X])  <b>BEKOMAT® 12i</b> <b>BEKOMAT® 12i CO</b>  <b>BEKOMAT® 12i CO PN63</b>	2000049  2000748

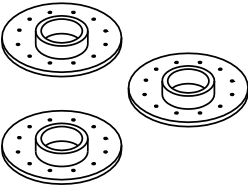
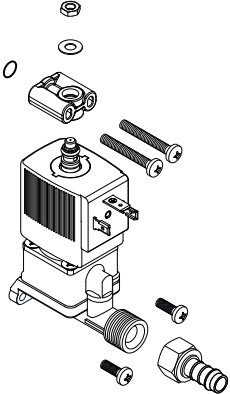
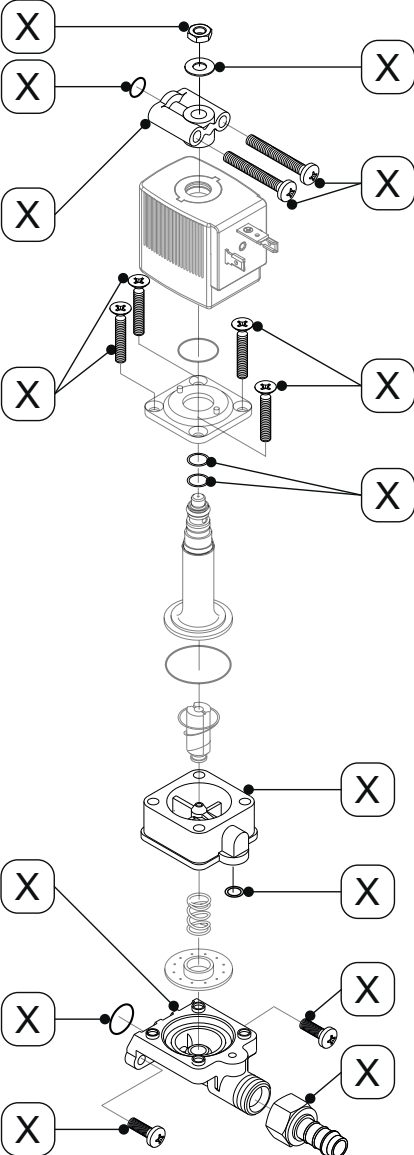
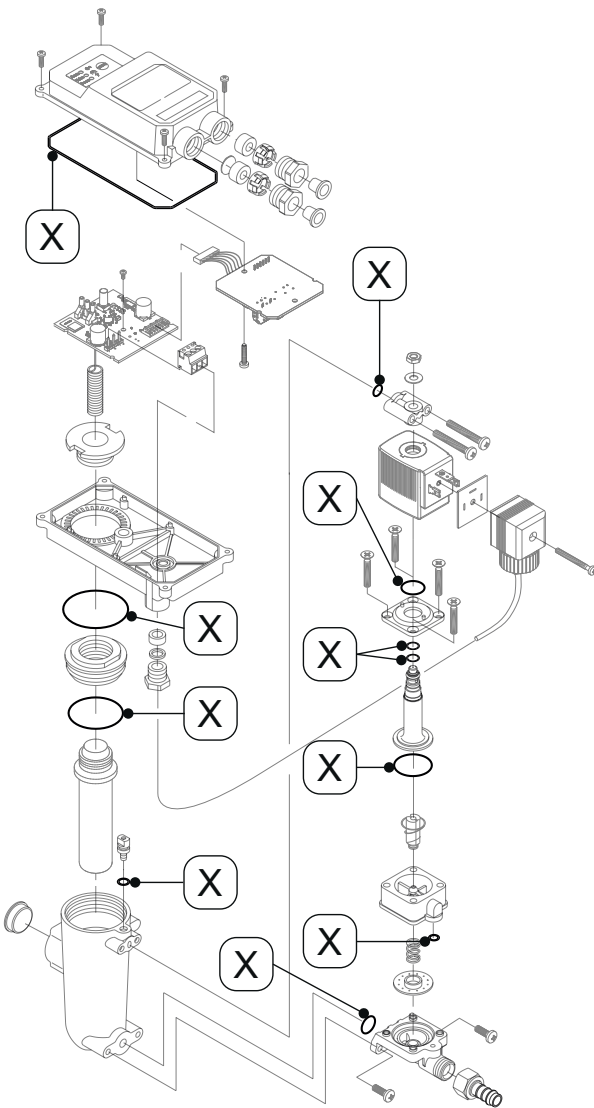
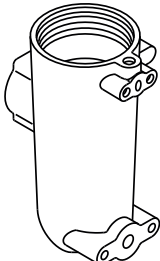
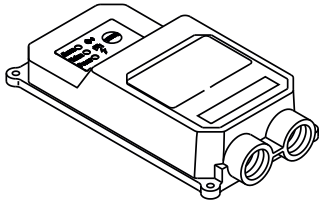



Illustration	Description	Material no.
	<p>Membranes, 3 pieces</p> <p><b>BEKOMAT® 12i</b>  <b>BEKOMAT® 12i CO</b>  <b>BEKOMAT® 12i CO PN63</b></p>	<p>4003555                  2000437</p>
	<p>Valve unit</p> <p><b>BEKOMAT® 12i</b>  <b>BEKOMAT® 12i CO</b>  <b>BEKOMAT® 12i CO PN63</b></p>	<p>4027846                  4027847                  4027848</p>
	<p>Valve attachment components                  (contains the marked components [X])</p> <p><b>BEKOMAT® 12i</b>  <b>BEKOMAT® 12i CO</b>  <b>BEKOMAT® 12i CO PN63</b></p>	<p>2000052                  2000053                  2000054</p>

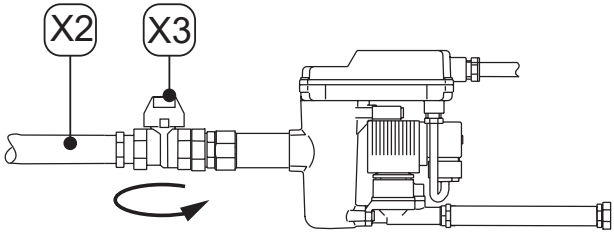
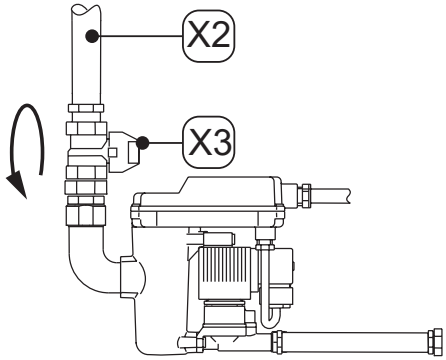
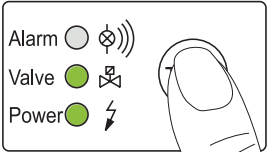
Illustration	Description	Material no.
	<p>Set of seals (contains the marked components [X])</p> <p><b>BEKOMAT® 12i</b> <b>BEKOMAT® 12i CO</b></p> <p><b>BEKOMAT® 12i CO PN63</b></p>	<p>2000058</p> <p>2000749</p>
	<p>Housing</p> <p><b>BEKOMAT® 12i</b></p> <p><b>BEKOMAT® 12i CO</b></p> <p><b>BEKOMAT® 12i CO PN63</b></p>	<p>2000060</p> <p>2000061</p> <p>2000234</p>
	<p>Top cover</p>	<p>2000066</p>

## 12. Decommissioning

### 12.1 Warning notices




<b>DANGER</b>	<b>Pressurised system!</b>
	<p>There is a danger of death or serious personal injury resulting from contact with fast or suddenly escaping fluids or through bursting system parts.</p>
	<ul style="list-style-type: none"> <li>• All work on the system must be carried out in the depressurised state and with the system secured against unintentional pressurisation.</li> <li>• Set up a safety area around the working area during all maintenance and repair work.</li> </ul>
<b>DANGER</b>	<b>Electric voltage!</b>
	<p>There is a danger of death or serious injuries as well as malfunction and device failure following contact with components which are in contact with electric voltage.</p>
	<ul style="list-style-type: none"> <li>• Only carry out maintenance and repair work on the product when it has been disconnected and secured against being switched back on again unintentionally.</li> <li>• Set up a safety area around the working area during all maintenance and repair work.</li> </ul>
<b>WARNING</b>	<b>Insufficient qualification!</b>
	<p>Insufficient qualification of the personnel carrying out work on the product and accessories can lead to accidents, personal injury and damage to property as well as impair operation.</p>
	<ul style="list-style-type: none"> <li>• All work on the product and the accessories may only be carried out by skilled technical personnel - customer service.</li> </ul>

## 12.2 Decommissioning work

Illustration	Description / explanation
 <hr/> 	<ol style="list-style-type: none"> <li>1. Interrupt the condensate feed via the condensate inlet line <b>[X2]</b> (e.g. by closing the recommended shut-off valve <b>[X3]</b>).</li> </ol>
	<ol style="list-style-type: none"> <li>2. Press the TEST button briefly multiple times.                     <ul style="list-style-type: none"> <li>→ The pressure in the <b>BEKOMAT®</b> is reduced.</li> <li>→ The condensate remaining in the <b>BEKOMAT®</b> is drained.</li> </ul> </li> <li>3. Disconnect the <b>BEKOMAT®</b> from the voltage supply and switch off all power.</li> </ol>


## 13. Dismantling

### 13.1 Warning notices

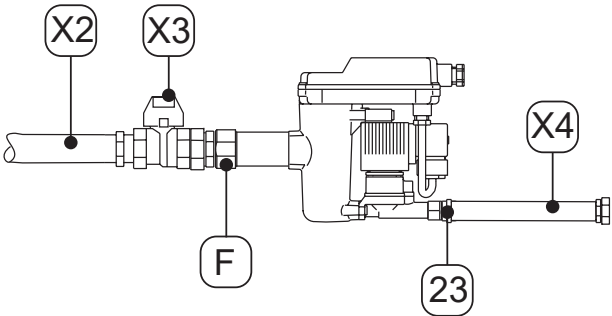
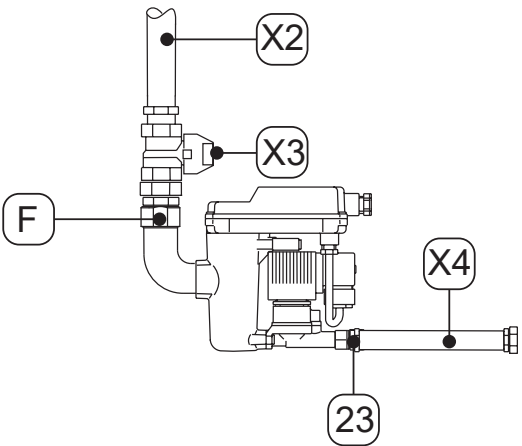
<b>DANGER</b>	<b>Pressurised system!</b>
	<p>There is a danger of death or serious personal injury resulting from contact with fast or suddenly escaping fluids or through bursting system parts.</p>
	<ul style="list-style-type: none"> <li>• All work on the system must be carried out in the depressurised state and with the system secured against unintentional pressurisation.</li> <li>• Set up a safety area around the working area during all maintenance and repair work.</li> </ul>
<b>DANGER</b>	<b>Electric voltage!</b>
	<p>There is a danger of death or serious injuries as well as malfunction and device failure following contact with components which are in contact with electric voltage.</p>
	<ul style="list-style-type: none"> <li>• Only carry out maintenance and repair work on the product when it has been disconnected and secured against being switched back on again unintentionally.</li> <li>• Set up a safety area around the working area during all maintenance and repair work.</li> </ul>
<b>WARNING</b>	<b>Insufficient qualification!</b>
	<p>Insufficient qualification of the personnel carrying out work on the product and accessories can lead to accidents, personal injury and damage to property as well as impair operation.</p>
	<ul style="list-style-type: none"> <li>• All work on the product and the accessories may only be carried out by skilled technical personnel - customer service.</li> </ul>

### 13.2 Dismantling work

For dismantling work to be carried out, the following prerequisites must be fulfilled and the preparatory tasks must have been completed.

Prerequisites		
Tools	Material	Protective equipment
<ul style="list-style-type: none"> <li>Spanner or adjustable end wrench</li> </ul>	<ul style="list-style-type: none"> <li>No material necessary</li> </ul>	Always to be worn: 



Preparatory tasks	
1.	Decommissioning has been completed.
2.	Depressurise the pressurised system or the respective system section and secure it against unintentional pressurisation.

Dismantling work	
Illustration	Description / explanation
	1. Remove the hose [X4] from the hose connection [23] and disassemble.
	2. Remove the condensate inlet line [X2] and the recommended shut-off valve [X3] from the condensate inlet [F] and disassemble.  3. Disassemble all power supplies.



## 14. Disposal

### 14.1 Warning notices

<b>NOTE</b>	<b>Inappropriate disposal!</b>
	<p>Inappropriate disposal of parts and components, operating and auxiliary materials as well as cleaning media can cause environmental damage.</p> <ul style="list-style-type: none"> <li>• Dispose of all components and parts, operating and auxiliary materials as well as cleaning media professionally and in accordance with regional legal provisions, regulations and requirements.</li> <li>• In case of uncertainties regarding disposal, always consult a regional waste management company.</li> </ul>
<b>INFORMATION</b>	<b>Disposal of electrical and electronic equipment</b>
	<p>Electrical and electronic equipment (EEE) contains materials, components and substances which can be dangerous and harmful to human health and the environment if the waste from electrical and electronic equipment (WEEE) is not disposed of properly.</p> <p>Electrical and electronic equipment are marked by the crossed out rubbish bin. The crossed out rubbish bin symbolises that electrical and electronic equipment must be collected separately and must not be disposed of together with unsorted domestic waste.</p> <p>For this purpose, all communities have set up collecting systems where waste from electronic equipment or electrical and equipment can be handed in free of charge to recycling stations or other collecting points or can be collected directly from households. Contact the technical office of your local authority for further information.</p> <p>Electrical and electronic equipment may not be disposed of with normal household waste. Users must use the communal collecting systems to reduce the environmental impact of the disposal of electrical and electronic appliances and improve the possibilities for recycling and reusing used electrical and electronic equipment.</p>

## 14.2 Disposal of operational materials and components

Ensure the following prerequisites are met before disposal:

Preparatory tasks	
1.	The <b>BEKOMAT®</b> has been decommissioned.
2.	The <b>BEKOMAT®</b> is disassembled.
3.	The <b>BEKOMAT®</b> is clean and free from all media residues.






Operating material / components	EU waste code
Adsorption materials, filter materials, cleaning wipes and protective clothing - contaminated by oils or other hazardous substances	15 02 02
Adsorption materials, filter materials, cleaning wipes and protective clothing - with the exception of those classified by 15 02 02	15 02 03
Packaging - paper and cardboard	15 01 01
Packaging - plastic material	15 01 02
Electric and electronic devices with the exception of those covered by 20 01 21, 20 01 23 and 20 01 35	20 01 36

## 15. Troubleshooting and fault repair / FAQ

Error or fault pattern	Possible causes	Troubleshooting
	<ul style="list-style-type: none"> <li>Negative power-on self-test. → The electronics unit is defective.</li> </ul>	<ul style="list-style-type: none"> <li>Contact <b>BEKO TECHNOLOGIES</b> customer service (see “1.1 Contact” on Page 5).</li> </ul>
	<ul style="list-style-type: none"> <li>All LEDs are off.</li> </ul>	<ul style="list-style-type: none"> <li>Read off the operating voltage on the type plate and check it.</li> <li>Check whether voltage is applied to the terminals of the power control board (GND, +24 VDC).</li> <li>Check the connection terminals on the power control board.</li> </ul>
	<ul style="list-style-type: none"> <li>All LEDs are on continuously.</li> </ul>	<ul style="list-style-type: none"> <li>Disconnect the product from the voltage supply and reconnect after &gt;5 seconds.</li> <li>Inspect the circuit board for potential damage.</li> </ul>
	<ul style="list-style-type: none"> <li>No condensate is drained after the TEST button has been pressed.</li> </ul>	<ul style="list-style-type: none"> <li>Check the feed line and the drain line.</li> <li>Replace wear parts.</li> <li>Check the valve function by pressing the TEST button. → Valve switching can be heard clearly (clicking sound).</li> <li>Check the connection terminals on the control circuit board.</li> </ul>
	<ul style="list-style-type: none"> <li>Condensate is only drained when the TEST button is pressed.</li> </ul>	<ul style="list-style-type: none"> <li>Install the feed line at a slope &gt;3 %.</li> <li>Check whether the necessary minimum pressure has been reached (see “4. Technical data” on Page 27).</li> <li>Replace wear parts.</li> </ul>
	<ul style="list-style-type: none"> <li>The <b>BEKOMAT</b>® discharges continuously.</li> </ul>	<ul style="list-style-type: none"> <li>Clean the complete valve unit.</li> <li>Replace wear parts.</li> <li>Clean the sensor tube.</li> </ul>

## 16. Appendices

### 16.1 Approval certificates and declarations of conformity

Symbol	Description / explanation
	<p><b>CE marking</b></p> <p>The CE marking indicates that a product fulfils all the EU directives applicable for this product and that basic safety and health requirements were met during manufacturing of the product. The product may be sold on the European market.</p>
	<p><b>FCC marking</b></p> <p>The FCC marking indicates that a product fulfils the requirements of the Federal Communications Commission (FCC) and that basic safety and health requirements were met during manufacturing of the product. The product may be sold on the US American market.</p>
	<p><b>cTÜVus marking</b></p> <p>The cTÜVus marking indicates that a product fulfils the requirements of TÜV Rheinland for the Canadian and US American market and that basic safety and health requirements were met during manufacturing of the product. The product may be sold on the Canadian and US American market.</p>
	<p><b>EAC marking</b></p> <p>The EAC marking indicates that a product fulfils all the Eurasian directives applicable for this product and that basic safety and health requirements were met during manufacturing of the product. The product may be sold on the Eurasian market.</p>
	<p><b>WEEE marking</b></p> <p>The crossed out rubbish bin marks an electrical or electronic product that must not be disposed of with domestic waste at the end of its service life. Free collecting points for used electrical equipment as well as further acceptance points for reuse of the products are available for them to be returned. Addresses can be obtained from the local authorities.</p>



## 16.2 Declaration of Conformity

BEKO TECHNOLOGIES GMBH  
Im Taubental 7  
41468 Neuss

GERMANY

Tel: +49 2131 988-0  
www.beko-technologies.com



### EU-Konformitätserklärung

Wir erklären hiermit, dass die nachfolgend bezeichneten Produkte den Anforderungen der einschlägigen Richtlinien und technischen Normen entsprechen. Diese Erklärung bezieht sich nur auf die Produkte in dem Zustand, in dem sie von uns in Verkehr gebracht wurden. Nicht vom Hersteller angebrachte Teile und/oder nachträglich vorgenommene Eingriffe bleiben unberücksichtigt.

Produktbezeichnung:	Kondensatableiter
Modelle:	BEKOMAT® 12..., 13..., 14..., 16...
Spannungsvarianten:	24 VDC, 24 VAC, 48 VAC, 100 VAC, 115 VAC, 200 VAC, 230 VAC
Max. Betriebsdruck:	16 bar (g) (Standard) 25 bar (g) (nur BEKOMAT® 13 ... PN25, 14 ... PN25) 40 bar (g) (nur BEKOMAT® 13 ... PN40) 50 bar (g) (nur BEKOMAT® 13 ... PN50) 63 bar (g) (nur BEKOMAT® 12 ... PN63) 17,2 bar (g) (nur BEKOMAT® 12, 13, 14 ... CRN)
Produktbeschreibung und Funktion:	Kondensatableiter zur elektronisch niveaugeregelten Ableitung von Kondensat im Druckluftnetz.

#### Niederspannungs-Richtlinie 2014/35/EU

Angewandte harmonisierte Normen: EN 61010-1: 2010  
Kapitel 1-14, 16, 17, Anhang A-D, F, G, I-L, ZA

Die Geräte mit einer Betriebsspannung von 24 VDC, 24 VAC und 48 VAC fallen nicht in den Anwendungsbereich der Niederspannungs-Richtlinie.

#### EMV-Richtlinie 2014/30/EU

Angewandte harmonisierte Normen: EN 55011: 2009, Gruppe 1, Klasse B  
EN 61326-1:2013

#### Druckgeräte-Richtlinie 2014/68/EU (nur BEKOMAT 16)

Angewandtes  
Konformitätsbewertungsverfahren: Modul A  
Kategorie: I  
Beschreibung der Druckgeräte: Behälter für Fluide der Gruppe 2

#### ROHS II-Richtlinie 2011/65/EU

Die Vorschriften der Richtlinie 2011/65/EU zur Beschränkung der Verwendung bestimmter gefährlicher Stoffe in Elektro- und Elektronikgeräten werden erfüllt.

Der Hersteller trägt die alleinige Verantwortung für die Ausstellung dieser Konformitätserklärung.

Neuss, 13.10.2017

Unterzeichnet für und im Namen von:

BEKO TECHNOLOGIES GMBH

*(Handwritten Signature)*  
i.V. Christian Riedel

Leiter Qualitätsmanagement International

EU\_decl\_BM12\_13\_14\_16\_de\_10\_2017.docx

**BEKO TECHNOLOGIES GMBH**  
Im Taubental 7  
41468 Neuss

GERMANY

Tel: +49 2131 988-0  
www.beko-technologies.com



## EU Declaration of Conformity

We hereby declare that the products named below comply with the stipulations of the relevant directives and technical standards. This declaration only refers to products in the condition in which they have been placed into circulation. Parts which have not been installed by the manufacturer and/or modifications which have been implemented subsequently remain unconsidered.

Product designation:	Condensate drain
Type:	BEKOMAT® 12..., 13..., 14..., 16...
Supply voltage versions:	24 VDC, 24 VAC, 48 VAC, 100 VAC, 115 VAC, 200 VAC, 230 VAC
Maximum operating pressure:	16 bar (g) (Standard) 25 bar (g) (only BEKOMAT® 13 ... PN25, 14 ... PN25) 40 bar (g) (only BEKOMAT® 13 ... PN40) 50 bar (g) (only BEKOMAT® 13 ... PN50) 63 bar (g) (only BEKOMAT® 12 ... PN63) 17,2 bar (g) (only BEKOMAT® 12, 13, 14 ... CRN)
Product description and function:	Condensate drain for the electronically level-controlled discharge of condensate in the compressed-air system.

### Low Voltage Directive 2014/35/EU

Applied harmonised standards: EN 61010-1: 2010  
Chapter 1-14, 16, 17, appendix A-D, F, G, I-L, ZA

The devices with working voltage of 24 VDC, 24 VAC and 48 VAC are not in the scope of the Low-Voltage Directive.

### EMC Directive 2014/30/EU

Applied harmonised standards: EN 55011: 2009, group 1, class B  
EN 61326-1:2013

### Pressure Equipment Directive 2014/68/EU (only BEKOMAT 16)

Applied conformity assessment procedure: Module A  
Category: I  
Description of the pressure device: Container device for fluids of Group 2

### RoHS II Directive 2011/65/EU

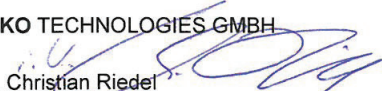
The products meet the requirements laid down in European Directive 2011/65/EU concerning the restriction of the use of certain hazardous substances in electrical and electronic devices.

The manufacturer shall have sole responsibility for issuing this declaration of conformity.

Signed for and on behalf of:

Neuss, 13/10/2017

**BEKO TECHNOLOGIES GMBH**

  
i.V. Christian Riedel  
Head of International Quality Management

**BEKO TECHNOLOGIES GmbH**

Im Taubental 7  
D - 41468 Neuss  
Tel. +49 2131 988 0  
Fax +49 2131 988 900  
info@beko-technologies.com  
service-eu@beko-technologies.com

**DE****BEKO TECHNOLOGIES LTD.**

Unit 11-12 Moons Park  
Burnt Meadow Road  
North Moons Moat  
Redditch, Worcs, B98 9PA  
Tel. +44 1527 575 778  
info@beko-technologies.co.uk

**GB****BEKO TECHNOLOGIES S.à.r.l.**

Zone Industrielle  
1 Rue des Frères Rémy  
F - 57200 Sarreguemines  
Tél. +33 387 283 800  
info@beko-technologies.fr  
service@beko-technologies.fr

**FR****BEKO TECHNOLOGIES B.V.**

Veenen 12  
NL - 4703 RB Roosendaal  
Tel. +31 165 320 300  
benelux@beko-technologies.com  
service-bnl@beko-technologies.com

**NL****BEKO TECHNOLOGIES  
(Shanghai) Co. Ltd.**

Rm.715 Building C, VANTONE Center  
No.333 Suhong Rd.Minhang District  
201106 Shanghai  
Tel. +86 (21) 50815885  
info.cn@beko-technologies.cn  
service1@beko.cn

**CN****BEKO TECHNOLOGIES s.r.o.**

Na Pankraci 58  
CZ - 140 00 Praha 4  
Tel. +420 24 14 14 717 /  
+420 24 14 09 333  
info@beko-technologies.cz

**CZ****BEKO Tecnológica España S.L.**

Torruella i Urpina 37-42, nave 6  
E - 08758 Cervelló  
Tel. +34 93 632 76 68  
Mobil +34 610 780 639  
info.es@beko-technologies.es

**ES****BEKO TECHNOLOGIES LIMITED**

Room 2608B, Skyline Tower,  
No. 39 Wang Kwong Road  
Kwoloon Bay Kwoloon, Hong Kong  
Tel. +852 2321 0192  
Raymond.Low@beko-technologies.com

**HK****BEKO TECHNOLOGIES INDIA Pvt. Ltd.**

Plot No.43/1 CIEEP Gandhi Nagar  
Balanagar Hyderabad  
IN - 500 037  
Tel. +91 40 23080275 /  
+91 40 23081107  
Madhusudan.Masur@bekoindia.com  
service@bekoindia.com

**IN****BEKO TECHNOLOGIES S.r.l**

Via Peano 86/88  
I - 10040 Leini (TO)  
Tel. +39 011 4500 576  
Fax +39 0114 500 578  
info.it@beko-technologies.com  
service.it@beko-technologies.com

**IT****BEKO TECHNOLOGIES K.K**

KEIHIN THINK Building 8 Floor  
1-1 Minamiwatarida-machi  
Kawasaki-ku, Kawasaki-shi  
JP - 210-0855  
Tel. +81 44 328 76 01  
info@beko-technologies.jp

**JP****BEKO TECHNOLOGIES Sp. z o.o.**

ul. Pańska 73  
PL - 00-834 Warszawa  
Tel. +48 22 314 75 40  
info.pl@beko-technologies.pl

**PL****BEKO TECHNOLOGIES S. de R.L. de C.**

BEKO Technologies, S de R.L. de C.V.  
Blvd. Vito Alessio Robles 4602 Bodega 10  
Zona Industrial  
Saltillo, Coahuila, 25107  
Mexico  
Tel. +52(844) 218-1979  
informacion@beko-technologies.com

**MX****BEKO TECHNOLOGIES CORP.**

900 Great Southwest Pkwy SW  
US - Atlanta, GA 30336  
Tel. +1 404 924-6900  
Fax +1 (404) 629-6666  
beko@bekousa.com

**US**