

EN - english



Instructions for installation and operation

**Compressed air refrigeration dryer
DRYPOINT® RA 10800-13200**

Dear customer,

Thank you for deciding in favour of the DRYPOINT® RA10800-13200 compressed-air refrigeration dryer. Please read these installation and operating instructions carefully before mounting and starting up the DRYPOINT® RA10800-13200 and follow our directions. Perfect functioning of the DRYPOINT® RA10800-13200 and thus reliable compressed-air drying can only be guaranteed when the provisions and notes stipulated here are strictly adhered to.

Contents

1	Name plate	5
2	Safety instructions	5
2.1	Safety pictograms in accordance with DIN 4844	6
2.2	Signal words in accordance with ANSI	8
2.3	Overview of the safety instructions	8
3	Proper use	11
4	Exclusion from a field of application	11
5	Operating instructions in accordance with the 2014/68/EU Pressure Equipment Directive	12
6	Transport	13
7	Storage	13
8	Installation	14
8.1	Place of installation	14
8.2	Installation plan	15
8.3	Correction factors	16
8.4	Connection to the compressed-air system	17
8.5	Connection to the cooling-water network	18
8.6	Minimum cooling-water requirements:	18
8.7	Electrical connections	19
8.8	Condensate drain	20
9	Start-up	20
9.1	Preliminary stages	20
9.2	Initial start-up	21
9.3	Start-up and shut down	22
10	Technical data	23
10.1	Technical data DRYPOINT RA10800-13200 3/400/50	23
11	Technical description	24
11.1	Control panel	24
11.2	Functional description	24
11.3	Flow chart (air-cooled)	25
11.4	Flow chart (water-cooled)	25
11.5	Refrigerating compressor	26
11.6	Condenser (air-cooled)	26
11.7	Condenser (water-cooled)	26
11.8	Cooling-water regulating valve	26
11.9	Filter dryer	26
11.10	Capillary tube	26
11.11	Aluminium heat exchanger	26
11.12	Hot-gas bypass valve	27
11.13	Refrigerant pressure switches LPS – HPS	27
11.14	Compressor crankcase heater	27
11.15	DMC 24 electronics (control unit compressed-air dryer)	28
11.15.1	Switching the dryer on	28
11.15.2	Switching the dryer off	28
11.15.3	Indication of the operating parameters – Info menu	28
11.15.4	Indication of a service warning	30
11.15.5	Alarm indication	31
11.15.6	Display of the alarm memory – log menu	32
11.15.7	Control of the dryer via remote control	32
11.15.8	Operation of the potential-free failure/alarm contact	32
11.15.9	Connection to a serial line	32
11.15.10	How to change operating parameters – SETUP menu	33
11.16	Electronically level-controlled BEKOMAT condensate drain	34
12	Maintenance, troubleshooting, spare parts and dismantling	35
12.1	Checks and maintenance	35
12.2	Troubleshooting	36
12.3	Recommended spare parts	41

12.4	Maintenance works at the refrigeration cycle	42
12.5	Dismantling the dryer	42
13	Appendices	43
13.1	Dryer dimensions	43
13.1.1	Dimensions DRYPOINT RA 10800-13200 air-cooled	43
13.1.2	Dimensions DRYPOINT RA 10800-13200 water-cooled	44
13.2	Exploded diagrams	45
13.2.1	Components of the exploded diagrams	45
13.2.2	Exploded diagram DRYPOINT RA 10800-13200 air-cooled	46
13.2.3	Exploded diagram DRYPOINT RA 10800-13200 water-cooled 1/2	47
13.2.4	Exploded diagram DRYPOINT RA 10800-13200 water-cooled 2/2	48
13.3	Electric diagrams	49
13.3.1	Electric diagrams – list of components	49
13.3.2	Electric diagrams DRYPOINT RA 10800 - Sheet 1/8	50
13.3.3	Electric diagrams DRYPOINT RA 10800 - Sheet 2/8	51
13.3.4	Electric diagrams DRYPOINT RA 10800 - Sheet 3/8	52
13.3.5	Electric diagrams DRYPOINT RA 10800 - Sheet 4/8	53
13.3.6	Electric diagrams DRYPOINT RA 10800 - Sheet 5/8	54
13.3.7	Electric diagrams DRYPOINT RA 10800 - Sheet 6/8	55
13.3.8	Electric diagrams DRYPOINT RA 10800 - Sheet 7/8	56
13.3.9	Electric diagrams DRYPOINT RA 10800 - Sheet 8/8	57
13.3.10	Electric diagrams DRYPOINT RA 13200 - Sheet 1/8	58
13.3.11	Electric diagrams DRYPOINT RA 13200 - Sheet 2/8	59
13.3.12	Electric diagrams DRYPOINT RA 13200 - Sheet 3/8	60
13.3.13	Electric diagrams DRYPOINT RA 13200 - Sheet 4/8	61
13.3.14	Electric diagrams DRYPOINT RA 13200 - Sheet 5/8	62
13.3.15	Electric diagrams DRYPOINT RA 13200 - Sheet 6/8	63
13.3.16	Electric diagrams DRYPOINT RA 13200 - Sheet 7/8	64
13.3.17	Electric diagrams DRYPOINT RA 13200 - Sheet 8/8	65
14	Declaration of conformity CE	66

1 Name plate

The name plate is on the back of the dryer and comprises all primary data of the device. Always refer to these data when contacting the manufacturer or the sales department.

All guarantee claims will expire in the event that the name plate is modified or removed.

The dryer model printed on the nameplate includes one or more suffixes that specify one or more features of dryer.

Explanation of 1st suffix for power supply requirements :

1st SUFFIX	DESCRIPTION OF FEATURE
none	3/400/50
-R	3/460/60
-S	3/230/60 (with internal autotransformer)
-F	3/380/60 (with internal autotransformer)
-T	3/690/60 (with internal autotransformer)

Explanation of 2nd suffix for cooling requirements :

2nd SUFFIX	DESCRIPTION OF FEATURE
/ AC	Air cooled
/ WC	Fresh water cooled
/ SWC	Sea water cooled, tube bundle condenser
/ TBH	Fresh water cooled, tube bundle condenser

Explanation of (eventual) 3rd suffix for special feature :

3rd SUFFIX	DESCRIPTION OF FEATURE
-TAC	Anti corrosion treatment
-SP	Special feature
-OF	Dryer oil free

Examples :

DP RA10800-R /AC	→	DRYPOINT RA10800, 3/460/60, Air cooled
DP RA10800 /SWC	→	DRYPOINT RA10800 3/400/50, Sea water cooled, tube bundle cond.
DP RA10800-T /WC	→	DRYPOINT RA10800 3/690/60, Water cooled

2 Safety instructions



Please check whether or not these instructions correspond to the device type.

Please adhere to all advice given in these operating instructions. They include essential information which must be observed during installation, operation and maintenance. Therefore, it must be ensured that these operating instructions are read by the fitter and the responsible operator / certified skilled personnel prior to installation, start-up and maintenance.

The operating instructions must be accessible at all times at the place of application of the DRYPOINT® RA10800-13200 compressed-air refrigeration dryer.

In addition to these operating instructions, local and national regulations need to be observed, where required.

Ensure that operation of the DRYPOINT® RA10800-13200 compressed-air refrigeration dryer only takes place within the permissible limit values indicated on the name plate. Any deviation from these limit values involves a risk for persons and for the material, and may result in malfunction or a breakdown.

After installing the device correctly and in accordance with the instructions in this manual, the dryer is ready to operate, further settings are not required. Operation is fully automatic and maintenance is limited to several examinations and cleaning measures which are described in the following chapters. This manual must be available at all times for future reference and is a constituent part of the dryer.

If you have any queries regarding these installation and operating instructions, please contact BEKO TECHNOLOGIES GMBH.

2.1 Safety pictograms in accordance with DIN 4844



Observe operating instructions



General danger symbol



Supply voltage



Danger: component or system under pressure



Hot surfaces



Non-breathable air



Do not use water to extinguish the fire



Do not operate with open cover (housing)



Maintenance works or controlling measures must only be carried out by qualified personnel ¹



Do not smoke



Note



Connection point compressed-air inlet



Connection point compressed-air outlet



Connection point condensate drain

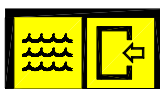

Connection point cooling-water inlet (water-cooled)

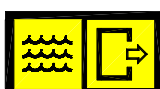

Connection point cooling-water outlet (water-cooled)

¹ Certified skilled personnel are persons who are authorised by the manufacturer, with experience and technical training, who are well-grounded in the respective provisions and laws and capable of carrying out the required works and of identifying and avoiding any risks during the machine transport, installation, operation and maintenance. Qualified and authorised operators are persons who are instructed by the manufacturer regarding the handling of the refrigeration system, with experience and technical training, and who are well-grounded in the respective provisions and laws.



Works can be carried out by the operator of the plant, provided that they are skilled accordingly ².

NOTE: Text that contains important specifications to be considered – does not refer to safety precautions.



The device was carefully designed with particular attention paid to environmental protection:

- CFC-free refrigerants
- CFC-free insulation material
- Energy-saving design
- Limited acoustic emissions
- Dryer and packaging comprise reusable materials

This symbol advises the user to observe the environmental aspects and comply with the recommendations connected with this symbol.

² Certified skilled personnel are persons who are authorised by the manufacturer, with experience and technical training, who are well-grounded in the respective provisions and laws and capable of carrying out the required works and of identifying and avoiding any risks during the machine transport, installation, operation and maintenance. Qualified and authorised operators are persons who are instructed by the manufacturer regarding the handling of the refrigeration system, with experience and technical training, and who are well-grounded in the respective provisions and laws.

2.2 Signal words in accordance with ANSI

Danger!	Imminent hazard Consequences of non-observance: serious injury or death
Warning!	Potential hazard Consequences of non-observance: possible serious injury or death
Caution!	Imminent hazard Consequences of non-observance: possible injury or property damage
Notice!	Potential hazard Consequences of non-observance: possible injury or property damage
Important!	Additional advice, info, hints Consequences of non-observance: disadvantages during operation and maintenance, no danger

2.3 Overview of the safety instructions



Certified skilled personnel

Installation works must exclusively be carried out by authorised and qualified skilled personnel. Prior to undertaking any measures on the DRYPOINT® RA10800-13200 compressed-air refrigeration dryer, the certified skilled personnel shall read up on the device by carefully studying the operating instructions. The operator is responsible for the adherence to these provisions. The respective directives in force apply to the qualification and expertise of the certified skilled personnel.

For safe operation, the device must only be installed and operated in accordance with the indications in the operating instructions. In addition, the national and operational statutory provisions and safety regulations, as well as the accident prevention regulations required for the respective case of application, need to be observed during employment. This applies accordingly when accessories are used.



Danger!

Compressed air!

Risk of serious injury or death through contact with quickly or suddenly escaping compressed air or through bursting and/or unsecured plant components.

Compressed air is a highly dangerous energy source.

Never work on the dryer when the system is under pressure.

Never direct the compressed-air outlet or condensate drain hoses at persons.

The user is responsible for the proper installation of the dryer. Non-observance of the instructions in the "Installation" chapter leads to the expiration of the guarantee. Improper installation may result in dangerous situations for the personnel and/or the device.



Danger!

Supply voltage!

Contact with non-insulated parts carrying supply voltage involves the risk of an electric shock resulting in injuries and death.

Only qualified and skilled personnel are authorised to run electrically-operated devices. Prior to undertaking maintenance measures at the device, the following requirements must be met:

Make sure that the power supply is switched off and that the device is off and marked for maintenance measures. Please also ensure that the power supply cannot be re-established during the works.



Caution!

Refrigerant!

The compressed-air refrigeration dryer uses HFC-containing refrigerants as a coolant.

Please observe the corresponding paragraph entitled "Maintenance works at the refrigeration cycle".

**Warning!****Refrigerant leak!**

A refrigerant leak involves the danger of serious injury and damage to the environment.



The DRYPOINT® RA10800-13200 compressed-air refrigeration dryer contains fluorinated greenhouse gas/refrigerant.

Installation, repair and maintenance works at the refrigeration system must only be carried out by certified skilled personnel (specialists). A certification in accordance with EC regulation 303/2008 must be available.



The requirements of the EC 842/2006 directive must be met under all circumstances.

Please refer to the indications on the name plate as regards the type and amount of refrigerant.



Comply with the following protective measures and rules of conduct:



- **Storage:** Keep the container tightly closed. Keep it in a cool and dry place. Protect it against heat and direct sunlight. Keep it away from ignition sources.
- **Handling:** Take measures against electrostatic charging. Ensure good ventilation/suction at the workplace. Check fittings, connections and ducts for tightness. Do not inhale the gas. Avoid contact with the eyes or the skin.
- Prior to carrying out works on refrigerant-carrying parts, remove the refrigerant to such an extent that safe working is possible.
- Do not eat, drink or smoke during work. Keep out of the reach of children.
- **Breathing protection:** ambient-air-independent respirator (at high concentrations).
- **Eye protection:** sealing goggles.
- **Hand protection:** protective gloves (e.g. made of leather).
- **Personal protection:** protective clothing.
- **Skin protection:** use protective cream.

In addition, the safety data sheet for the refrigerant needs to be observed!

**Caution!****Hot surfaces!**

During operation, several components can reach surface temperatures of more than +60°C. There is the risk of burns.

All components concerned are installed inside of the closed housing. The housing must only be opened by certified skilled personnel³.

**Caution!****Improper use!**

The device is intended for the separation of water in compressed air. The dried compressed air cannot be used for breathing-air purposes and is not suitable for the direct contact with food.

This dryer is not suitable for the treatment of contaminated air or of air containing solids.

³ Certified skilled personnel are persons who are authorised by the manufacturer, with experience and technical training, who are well-grounded in the respective provisions and laws and capable of carrying out the required works and of identifying and avoiding any risks during the machine transport, installation, operation and maintenance. Qualified and authorised operators are persons who are instructed by the manufacturer regarding the handling of the refrigeration system, with experience and technical training, and who are well-grounded in the respective provisions and laws.



Note!

Contaminated intake air!

In the event that the intake air is strongly contaminated (ISO 8573.1 class 3.-3 or poorer quality), we recommend the additional installation of a prefilter (e.g. CLEARPOINT F040), to avoid clogging of the heat exchanger.



Caution!

Heating-up through fire!

In the event of a heating-up through fire, the containers and pipes of the refrigerant system can burst.



In this case, please proceed as follows:

Switch off the refrigeration plant.

Switch off the mechanical ventilation of the machinery compartment.

Use ambient-air-independent respirators.

Containers and plants which are filled with refrigerant can burst violently in the event of fire.

The refrigerants themselves are incombustible, but they are degraded to very toxic products at high temperatures.

Remove the container/plant from the fire zone, as there is the risk of bursting!

Cool down containers and bottles via a directed water jet from a safe position.

In the event of fire, please use an approved fire extinguisher. Water is not a suitable agent to extinguish an electrical fire.

This must only be carried out by persons who are trained and informed about the hazards emanating from the product.



Caution!

Unauthorised intervention!

Unauthorised interventions may endanger persons and plants and lead to malfunction.

Unauthorised interventions, modification and abuse of the pressure devices are prohibited.

The removal of sealings and leadings at safety devices is prohibited.

Operators of the devices must observe the local and national pressure equipment regulations in the country of installation.



Note!

Ambient conditions!

In the event that the dryer is not installed under suitable ambient conditions, the ability of the device to condense refrigerant gas is impaired. This can result in a higher load of the refrigerating compressor, and in a loss of efficiency and performance of the dryer.

This in turn leads to overheated condenser fan motors, to malfunction of electric components and to a breakdown of the dryer. Failures of this type will affect warranty considerations.

Do not install the dryer in an environment in which chemicals with a corrosive effect, explosive gases, toxic gases, evaporation heat, high ambient temperatures or extreme dust and dirt can be found.

3 Proper use

This dryer was designed, manufactured and tested to separate the moisture which normally exists in compressed air. Any other use is considered improper.

The manufacturer shall not be liable for problems occurring as a consequence of improper use. The user alone is responsible for any damage resulting from that.

Furthermore, the correct use includes the compliance with the installation instructions, in particular in respect of:

- The voltage and frequency of the main voltage supply.
- The pressure, temperature and flow rate of the inlet air.
- The pressure, temperature and cooling-water throughput (water-cooled).
- The ambient temperature.

When delivered, the dryer is tested and fully assembled. The customer only needs to connect the device to the system in accordance with the instructions in the following chapters.

4 Exclusion from a field of application



Note!

Improper use!



The device is intended for the separation of water in compressed air. The dried compressed air cannot be used for breathing-air purposes and is not suitable for the direct contact with food.

This dryer is not suitable for the treatment of contaminated air or of air containing solids.

5 Operating instructions in accordance with the 2014/68/EU Pressure Equipment Directive

The DRYPOINT® RA10800-13200 compressed-air refrigeration dryer contains pressure equipment in the sense of the 2014/68/EU Pressure Equipment Directive. Therefore, the entire plant needs to be registered with the supervisory authority if required in accordance with the local regulations.

For the examination prior to the start-up and for periodic inspections, the national regulations need to be observed, such as the industrial safety regulation in the Federal Republic of Germany. In countries outside the EU, the respective regulations in force there need to be adhered to.

The proper use of pressure devices is the basic requirement for safe operation. As regards pressure devices, the following points need to be observed:

- The DRYPOINT® RA10800-13200 compressed-air refrigeration dryer must only be employed within the pressure and temperature range limits indicated by the manufacturer on the name plate.
- No welding must be carried out on the pressure parts.
- The DRYPOINT® RA10800-13200 compressed-air refrigeration dryer must neither be installed in insufficiently ventilated rooms nor near heat sources or inflammable substances.
- To avoid fractures resulting from material fatigue, the refrigeration dryer should not be exposed to vibrations during operation.
- The maximum operating pressure indicated by the manufacturer on the name plate must not be exceeded. It is the installer's responsibility to install the appropriate safety and control devices. Prior to the start-up of the DRYPOINT® RA10800-13200 compressed-air refrigeration dryer, the connected pressure generator (compressor etc.) must be set to the max. permissible operating pressure. The integrated safeguard needs to be checked by an approved inspection agency.
- The documents related to the DRYPOINT® RA10800-13200 compressed-air refrigeration dryer (manual, operating instructions, manufacturer's declaration etc.) must be kept safe for future reference.
- No objects whatsoever must be installed at or placed on the DRYPOINT® RA10800-13200 compressed-air refrigeration dryer and the connecting lines.
- Installation of the plant in frost-free places only.
- Operation of the plant is only permissible with fully closed and intact housing and cover panels. Operation of the plant with damaged housing/cover panels is prohibited.

6 Transport

Check the packaging for visible loss or damage. If no visible damage can be ascertained, place the unit in close proximity to the place of installation and unpack the device.

During this procedure, the dryer must always remain in an upright position. The components may be damaged when the unit is tilted or turned upside down.

Store the device in a dry environment and do not expose it to extreme weather conditions.

Handle with care. Strong shocks can cause irreparable damage.

7 Storage

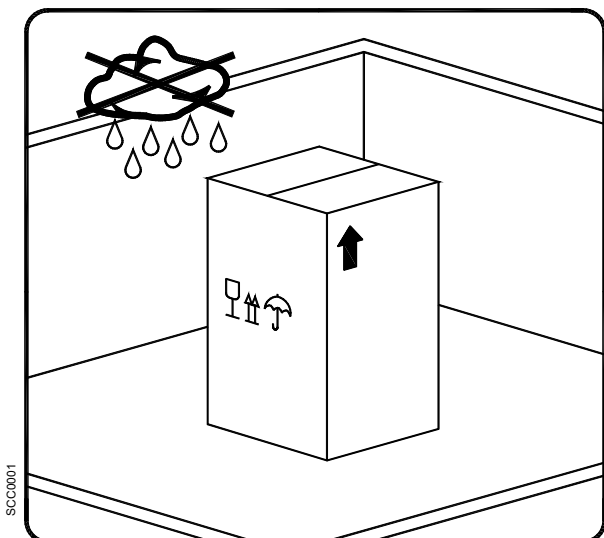

Keep the device away from extreme weather conditions even when packaged.

Keep the dryer in an upright position, also while it is stored. Tilting the device or turning it upside down can cause irreparable damage to some components.

When the dryer is not in use, it can be stored in its packaging in a dust-free and protected place at a temperature of +1°C ... +50°C and at a specific humidity of max. 90%. If the storage period exceeds 12 months, you should contact the manufacturer.



The packaging material is recyclable. Dispose of the material in accordance with the directives and provisions in force in the country of destination

8 Installation

8.1 Place of installation



Note!

Ambient conditions!

In the event that the dryer is not installed under suitable ambient conditions, the ability of the device to condense refrigerant gas is impaired. This can result in a higher load of the refrigerating compressor, and in a loss of efficiency and performance of the dryer.

This in turn leads to overheated condenser fan motors, to malfunction of electric components and to a breakdown of the dryer. Failures of this type will affect warranty considerations.

Do not install the dryer in an environment in which chemicals with a corrosive effect, explosive gases, toxic gases, evaporation heat, high ambient temperatures or extreme dust and dirt can be found.

Minimum installation requirements:

- Choose an area which is clean and dry, free from dust and protected against atmospheric disturbances.
- The load-bearing zone must be even, horizontal and able to bear the weight of the dryer.
- Minimum ambient temperature +1°C.
- Maximum ambient temperature +50°C.
- Ensure a proper cooling air replacement.
- Allow a sufficient clearance on each side of the dryer for proper ventilation and to facilitate maintenance operations. The dryer does not require attachment to the floor surface.



Do not obstruct the ventilation grille (not even partially).

Prevent any recirculation of the outgoing cooling air.

Protect the dryer against draughts.

8.2 Installation plan

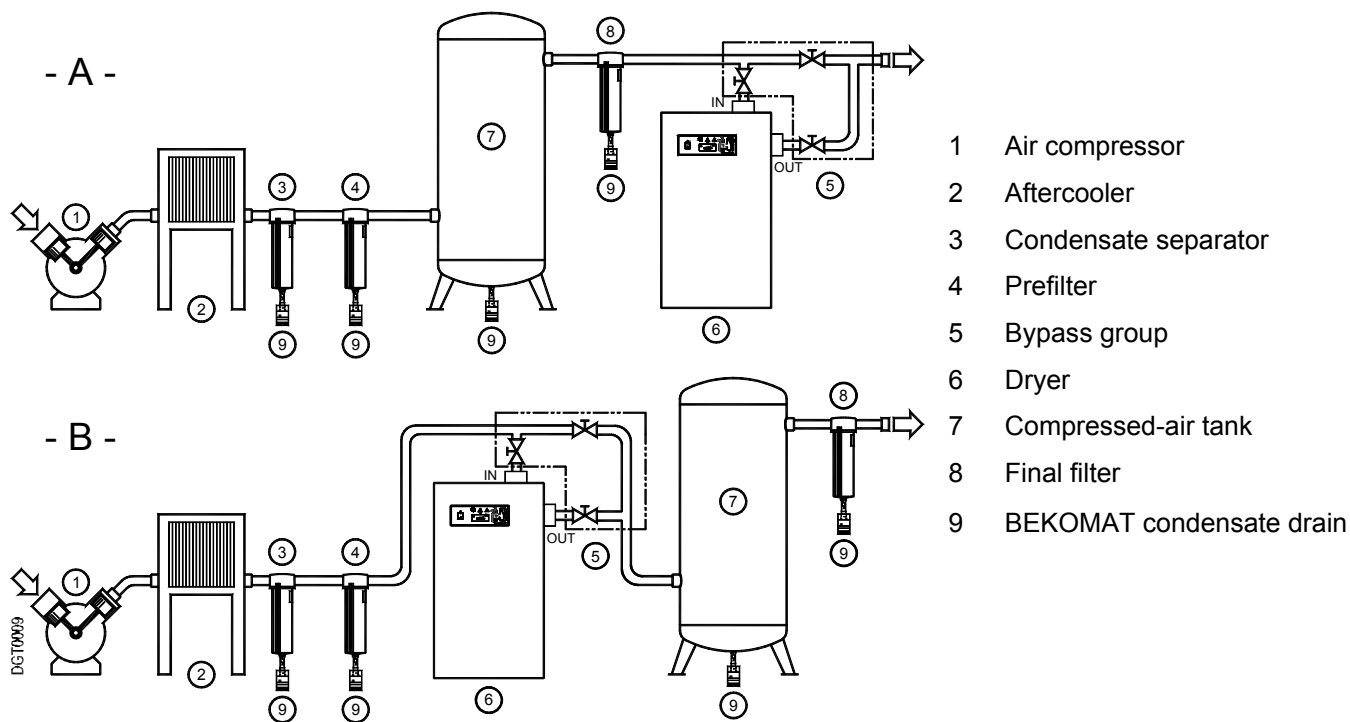

Installation **type A** is recommended when the total consumption corresponds to the throughput rate of the compressor.

Installation **type B** is recommended when the air consumption constantly varies, with peak values which considerably exceed the throughput rate of the compressor. The storage capacity of the tank must be dimensioned in such a way that a possible short-term high air demand (peak air consumption) can be compensated.



Do not obstruct the ventilation grille (not even partially).

Prevent any recirculation of the outgoing cooling air.
 Protect the dryer against draughts.



Note!

Contaminated intake air!

In the event that the intake air is strongly contaminated (ISO 8573.1 class 3.-3 or poorer quality), we recommend the additional installation of a prefilter (e.g. CLEARPOINT F040), to avoid clogging of the heat exchanger.

8.4 Connection to the compressed-air system



Danger!

Compressed air!

All works must only be carried out by qualified skilled personnel.

Never work on compressed-air systems which are under pressure.



The operator or the user must ensure that the dryer is never operated with a pressure exceeding the maximum pressure value indicated on the name plate.

Exceeding the maximum operating pressure can be dangerous for the operator but also for the device.

The air temperature and the air flow at the inlet of the dryer must lie within the limit values indicated on the name plate. The connecting lines must be free from dust, iron rust, shards and other contaminations and correspond to the flow rate of the dryer. Should air with a very high temperature be treated, the installation of an aftercooler may be necessary. For the implementation of maintenance works, the installation of a bypass system is recommended.

The dryer was designed in such a manner that vibrations that may occur during operation are limited. Therefore, it is advisable to employ connecting lines (flexible hoses, vibration-inhibiting fittings etc.) which protect the dryer against possible vibrations in the pipework.

Note!

Contaminated intake air!

In the event that the intake air is strongly contaminated (ISO 8573.1 class 3.-3) or poorer quality, we recommend the additional installation of a prefilter (e.g. CLEARPOINT F040), to avoid clogging of the heat exchanger.



8.5 Connection to the cooling-water network



Danger!

Compressed air and unqualified personnel!

All works must only be carried out by qualified skilled personnel.
Never work on compressed-air systems which are under pressure.

The user must ensure that the dryer is never operated with a pressure exceeding the nominal values.
Possible overpressure can be dangerous for the operator but also for the device.



The temperature and the amount of cooling water need to correspond to the limit values indicated on the name plate. The cross-section of the connecting lines, which should preferably be flexible, must be free from dust, iron rust, shards and other contaminations. We recommend employing connecting lines (flexible hoses, vibration-inhibiting fittings etc.) which protect the dryer against possible vibrations in the pipework.



Note!

Contaminated intake water!

In the event that the intake water is strongly contaminated we recommend the additional installation of a prefilter (500 micron), to avoid clogging of the heat exchanger.

8.6 Minimum cooling-water requirements:

Temperature	15 ... 30°C (1)	HCO ₃ / SO ₄	>1.0 mg/l or ppm
Pressure	3...10 bar(g) (2)	NH ₃	<2 mg/l or ppm
Delivery pressure	> 3 bar (2) (3)	Cl ⁻	<50 mg/l or ppm
Total hardness	6.0...15 dH°	Cl ₂	<0.5 mg/l or ppm
PH	7.5...9.0	H ₂ S	<0.05 mg/l or ppm
Conductivity	10...500 µS/cm	CO ₂	<5 mg/l or ppm
Residual solids	<30 mg/l or ppm	NO ₃	<100 mg/l or ppm
Saturation mark SI	-0.2 < 0 < 0.2	Fe	<0.2 mg/l or ppm
HCO ₃	70...300 mg/l or ppm	Al	<0.2 mg/l or ppm
SO ₄ ²⁻	<70 mg/l or ppm	Mn	<0.1 mg/l or ppm

Note: (1) – Other temperatures upon request – check the data on the name plate.

(2) – Other pressures upon request – check the data on the name plate.

(3) – Pressure difference at the water connection of the dryer at maximum water flow.
Other delivery pressures upon request.



CAUTION!

During the piping of the dryer, the inlet and outlet connections need to be supported as is shown in the illustration.

Non-observance will cause damage.

8.7 Electrical connections



Danger!
Supply voltage!

The connection to the electric mains should only be carried out by qualified skilled personnel and must correspond to the legal provisions in force in your region.

Prior to connecting the device, please check the name plate to avoid exceeding the indicated values. The voltage tolerance is +/- 10%.

The installer is responsible for supplying and installing the power cable. Be sure to provide the proper fuses or breakers based on the data information located on the nameplate.

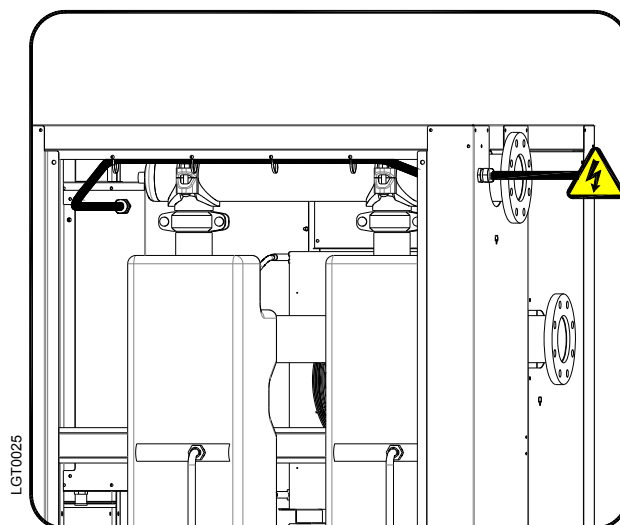

A residual-current device (RCD) with $I_{\Delta n} = 0.03A$ is suggested. The cross-section of the power supply cables must correspond to the consumption of the dryer. In this respect, the ambient temperature, the cable laying conditions, the length of the cables and the requirements of the local electricity supplier need to be considered.

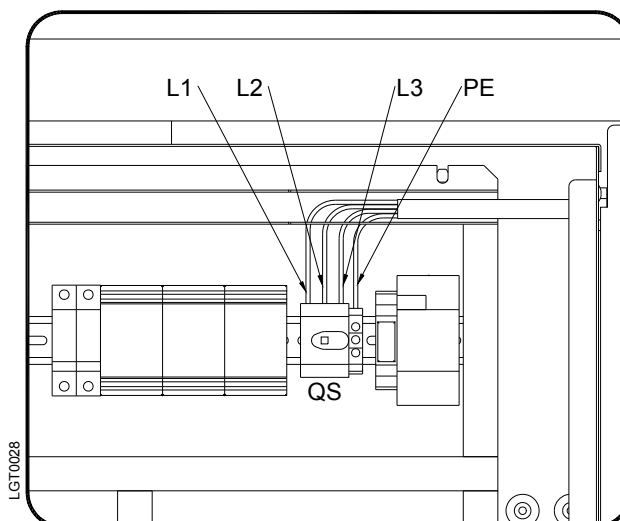

CAUTION!

Please observe the direction of rotation of the compressor!

In this system, the direction of rotation of the compressor is supervised by a reverse-phase protector (RPP).

When this guard is triggered, the DMC24 goes into alarm mode (the alarm LED flashes  and the display of the DMC24 shows **OFF** and **Con**). In the event that the compressor does not run, the direction of rotation must be changed by interchanging two phases. These modifications must only be carried out by a qualified electrician.

Do not by-pass the RPP protector: If the device is operated with the incorrect direction of rotation, the compressor will fail immediately. This will void the guarantee.



Danger!

Supply voltage and missing earth connection!

Important: ensure that the plant is connected to earth.

Do not use plug adapters at the power plug.

Possible replacement of the power plug must only be carried out by a qualified electrician.

8.8 Condensate drain



Danger!

Compressed air and condensate under pressure!

The condensate is discharged at system pressure.
The drain pipe needs to be secured.
Never direct the condensate drain pipe at persons.

The dryer is delivered with an already integrated electronically level-controlled BEKOMAT condensate drain. Connect the condensate drain with a collection system or container by properly screwing it on. Do not connect the drain with pressure plants.



Do not discharge the condensate into the environment.
The condensate accumulating in the dryer contains oil particles which were released into the air by the compressor.
Dispose of the condensate in accordance with the local provisions.

It is advisable to install a water-oil separator, to which the total amount of condensate from the compressors, dryers, tanks, filters etc. is supplied.
We recommend ÖWAMAT oil-water separators for dispersed compressor condensate and BEKOSPLIT emulsion-splitting plants for emulsified condensate.

9 Start-up

9.1 Preliminary stages



Note!

Exceeding of the operating parameters!

Ensure that the operating parameters comply with the nominal values indicated on the name plate of the dryer (voltage, frequency, air pressure, air temperature, ambient temperature etc.).

Prior to delivery, this dryer was thoroughly tested, packed and checked. Please verify the soundness of the dryer during the initial start-up and check the perfect functioning during the first operating hours.



The initial start-up must be carried out by qualified personnel.
During the installation and operation of this device, all national regulations regarding electronics and any other federal and state ordinances, as well as local provisions, need to be adhered to.

The operator and the user must ensure that the dryer is not operated without panels.



9.2 Initial start-up



Note!

The dryer **must not be started up more than six times an hour**. Wait at least five minutes prior to every restart.



The user is responsible for the compliance with these provisions. Irreparable damage can be caused by starting up the device too often.



The method below should be applied during the first start-up, after longer downtimes or subsequent to maintenance works.

The start-up must be carried out by certified skilled personnel.

Processing sequence (observe Section 11.1 "Control panel")

- Ensure that all steps of the "Installation" chapter have been carried out.
- Ensure that the connection to the compressed-air system is in accordance with the provisions and that the lines are fixed and supported properly.
- Ensure that the condensate drain pipe is fixed in accordance with the provisions and that it is connected with a collection system or a container.
- Ensure that the bypass system (if available) is open and that the dryer is isolated.
- Ensure that the manual valve of the condensate outlet is open.
- Ensure that the cooling-water flow and the temperature are in accordance with the provisions (water-cooled).
- Remove any packaging material and other items which may block the space around the dryer.
- Switch on the main switch.
- Switch on the main switch on the control panel (pos. 1).
- The display of the DMC24 shows **oFF**.
- **When the alarm LED flashes  and the display of the DMC24 shows **oFF** and **Con**, the current phases are not connected correctly. Change two of the three phases at the supply mains (see Section 8.7).**
- Wait at least two hours before starting the dryer (the crankcase heater of the compressor needs to heat up the compressor oil).
- Press the  button for at least two seconds to start the dryer: If the compressor was out of operation for a sufficient period of time, it will start immediately. If this is not the case, the display shows the countdown of the seconds until the compressor restarts and the  LED flashes (max. delay five minutes).
- Make sure that the consumption complies with the values of the name plate.
- **Ensure that the direction of rotation of the fan corresponds to the arrows on the condenser (air-cooled).**
- Wait until the dryer stabilises at the preset value.
- Slowly open the air inlet valve.
- Slowly open the air outlet valve.
- Slowly close the central bypass valve of the system (if installed).
- Check the pipes for air leakage.
- Ensure that the drain discharges at regular intervals – wait for the first interventions.



CAUTION!

Please observe the direction of rotation of the compressor!

In this system, the direction of rotation of the compressor is supervised by a reverse-phase protector (RPP).

When this guard is triggered, the alarm will be activated at the DMC24 (the alarm LED flashes  and the display of the DMC24 shows **oFF** and **Con**). In the event that the compressor does not run, the direction of rotation must be changed by interchanging two phases. These modifications must only be carried out by a qualified electrician.

Do not by-pass the RPP protector: If the device is operated with the incorrect direction of rotation, the compressor will fail immediately. This will void the guarantee.



9.3 Start-up and shut down



During short-term shut down (max. two to three days), it is advisable to leave the dryer and the control panel connected to the supply current circuit. Otherwise, it would be necessary at a restart of the dryer to wait two hours, until the oil in the compressor has reached the specified operating temperature.



Start-up (see Section 11.1 "Control panel")

- Make sure that the condenser is clean (air-cooled).
- Ensure that the cooling-water flow and the temperature are in accordance with the provisions (water-cooled).
- Display DMC24 shows **OFF**.
- Press the  button for at least two seconds to start the dryer: If the compressor was out of operation for a sufficient period of time, it will start immediately. If this is not the case, the display shows the countdown of the seconds until the compressor restarts and the  LED flashes (max. delay five minutes).
- Wait for several minutes and then check whether or not the dew point temperature which is indicated on the display of the DMC24 electronics is correct and whether or not the condensate is discharged at regular intervals.
- Switch on the air compressor.



Shut down (see Section 11.1 "Control panel")

- Ensure that the dew point temperature indicated on the DMC24 is within the permissible range.
- Shut down the air compressor.
- Switch the dryer off after several minutes by pressing the  button on the DMC24 for at least two seconds. The display then shows **OFF**.



Dryer remote control ON/OFF

- See instructions in Section 11.15.7



Only use potential-free contacts that are suitable for low voltage. Ensure the sufficient insulation of potentially dangerous voltage-carrying components.



CAUTION!

**Automatic restart / remote control ON/OFF. The unit may start up without any active influence!
The user will be responsible for the installation of proper protections for possible sudden power restoration to the dryer.**



Note!

A dew point between 0°C and +10°C displayed on the control unit is considered to be correct according to the possible operating conditions (flow rate, air inlet temperature, ambient temperature etc.).

During the operation, the refrigerating compressor runs continuously. The dryer needs to be switched on during the entire compressed-air usage time, even if the compressed-air compressor works periodically.



Note!

The dryer **must not be started up more than six times an hour**. Wait at least five minutes prior to every restart.
The user is responsible for the compliance with these provisions. Irreparable damage can be caused when starting up the device too often.

10 Technical data

10.1 Technical data DRYPOINT RA10800-13200 3/400/50

MODEL	RA	10800	13200
Air flow rate at nominal condition (1)	[m ³ /h]	10800	13248
	[l/min]	180000	220800
	[scfm]	6360	7800
Pressure DewPoint at nominal condition (1)	[°C]	3	
Nominal ambient temperature	[°C]	25	
Min...Max ambient temperature	[°C]	1...50	
Nominal inlet air temperature (max.)	[°C]	35 (70)	
Nominal inlet air pressure	[barg]	7	
Max. inlet air pressure	[barg]	14	
Air pressure drop - Δp	[bar]	0.22	0.28
Inlet - Outlet connections	[BSP-F]	DN200 PN16	

Air-Cooled	Refrigerant type	R407C		
	Refrigerant quantity (2)	[kg]	28.00	29.50
	Cooling air fan flow	[m ³ /h]	44400	
	Heat Rejection	[kW]	87.60	109.40
	Standard Power Supply (2)	[Ph/V/Hz]	3/400/50	
	Nominal electric consumption	[kW]	18.60	21.60
		[A]	33.9	41.0
	Full Load Amperage FLA	[A]	51.2	74.2
	Max. noise level at 1 m	[dbA]	<85	
	Weight	[kg]	1650	1830

Water-Cooled	Refrigerant type	R407C		
	Refrigerant quantity (2)	[kg]	22.00	26.00
	Max. cooling water inlet temp (3)	[°C]	30	
	Min...Max. cooling water inlet pressure	[barg]	3 ... 10	
	Cooling water flow at 15°C	[m ³ /h]	1.85	2.32
	Cooling water flow at 30°C	[m ³ /h]	6.10	7.60
	Heat Rejection	[kW]	87.60	109.40
	Control of cooling water flow		Automatic by valve	
	Cooling water connection	[BSP-F]	G 2"	
	Standard Power Supply (2)	[Ph/V/Hz]	3/400/50	
	Nominal electric consumption	[kW]	15.80	18.70
		[A]	27.8	34.4
	Full Load Amperage FLA	[A]	41.0	64.0
	Max. noise level at 1 m	[dbA]	< 80	
Weight	[kg]	1450	1660	

(1) The nominal condition refers to an ambient temperature of +25°C with inlet air at 7 barg and +35 °C.

(2) Check the data shown on the identification plate.

(3) Other temperature on request.

11 Technical description

11.1 Control panel

The control panel explained below is the only dryer user interface.

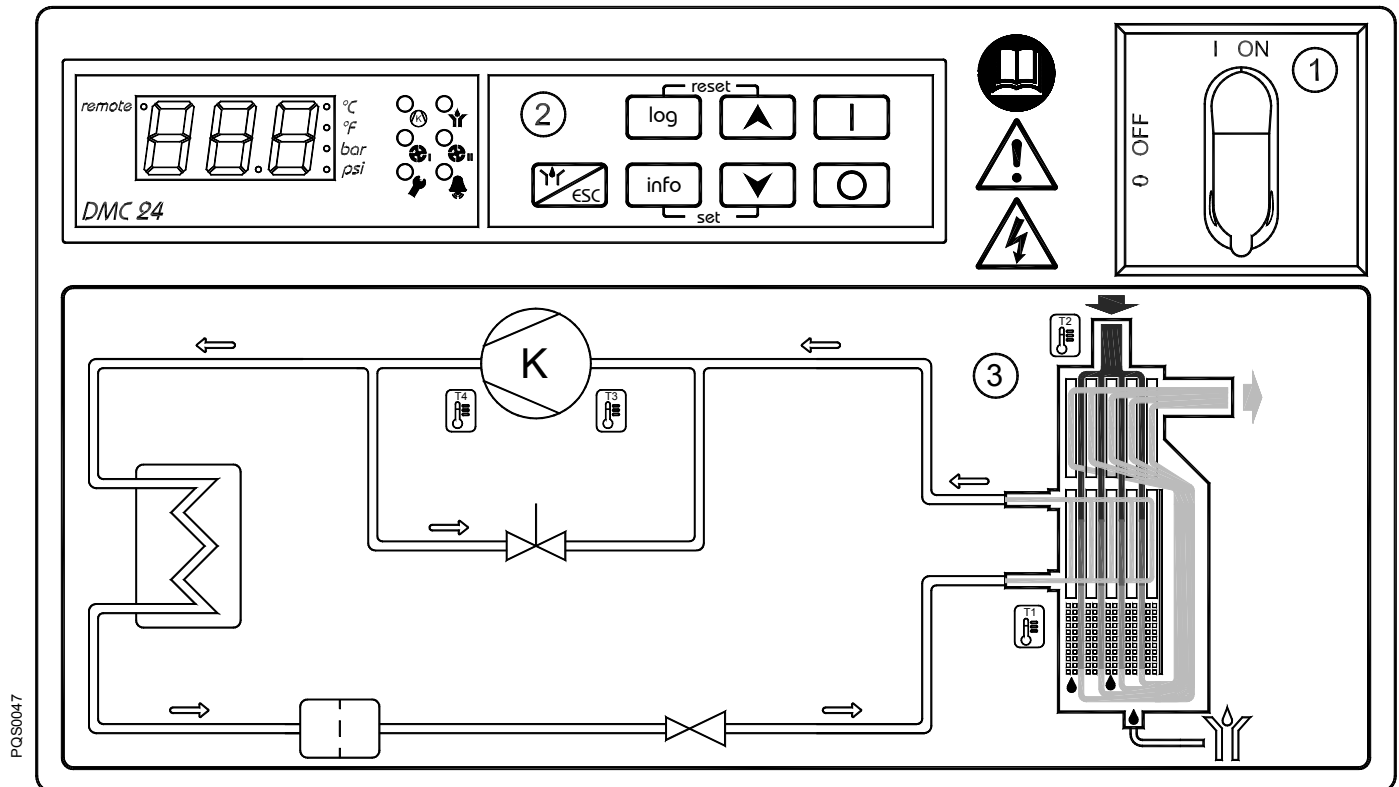

- 1 Main switch
- 2 Electronic control unit DMC 24
- 3 Air and refrigerant-gas flow chart

11.2 Functional description

Operating principle – All dryer models described in this manual function according to the same principle. The hot and moisture-loaded air is led into an air/air heat exchanger. Afterwards, the air flows through an evaporator, which is also known as an air/refrigerant heat exchanger. The air temperature is reduced to approximately 2°C, so that water vapour condenses to liquid. The continuously accumulating condensate is collected in the separator to be discharged via the condensate drain. Subsequently, the cold and dry air is led through the air/air heat exchanger, so that it is reheated to up to 8°C below the inlet temperature when leaving the dryer.

Refrigeration cycle – The refrigerant is conducted through the compressor and reaches a condenser under high pressure. There, cooling-down takes place, making the refrigerant condense to a liquid state which is under high pressure. The liquid is pressed through a capillary tube where the resulting pressure drop ensures that the refrigerant evaporates at a defined temperature. The liquid refrigerant which is under low pressure is led into the heat exchanger, where it expands. The cold resulting from the expansion serves to cool down the compressed air in the heat exchanger. During this process, the refrigerant evaporates. The low-pressure gas is resupplied to the compressor, where it is compressed again. It then re-enters the cycle. In phases of a reduced compressed-air load, the excess refrigerant is resupplied automatically to the compressor via the hot gas bypass valve.

11.3 Flow chart (air-cooled)

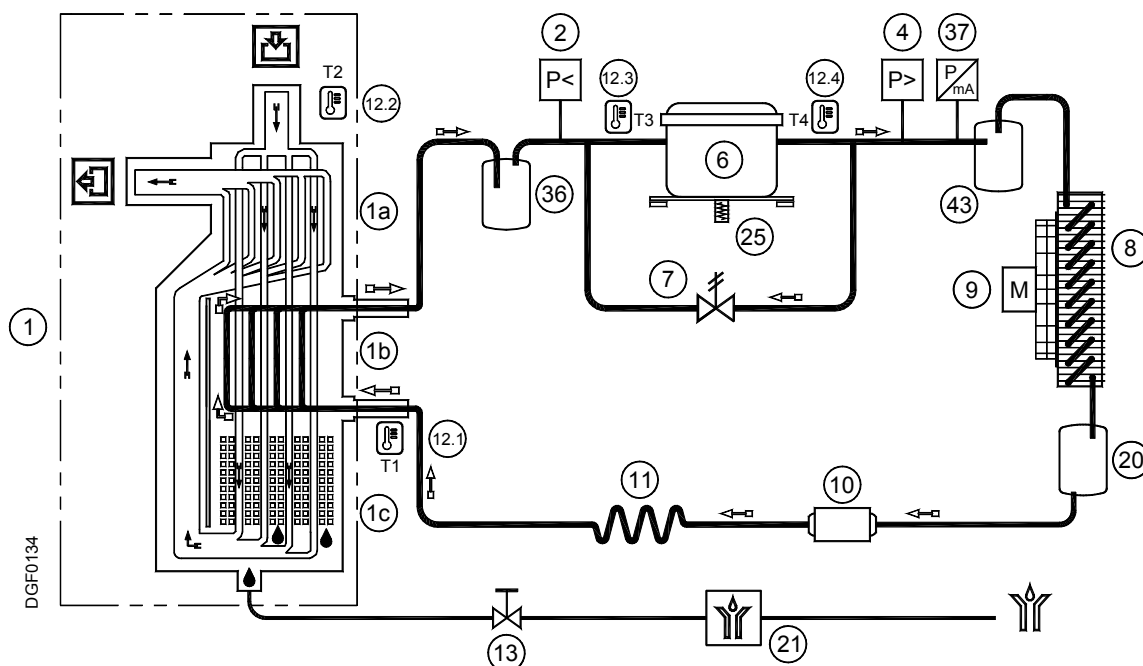

11.4 Flow chart (water-cooled)

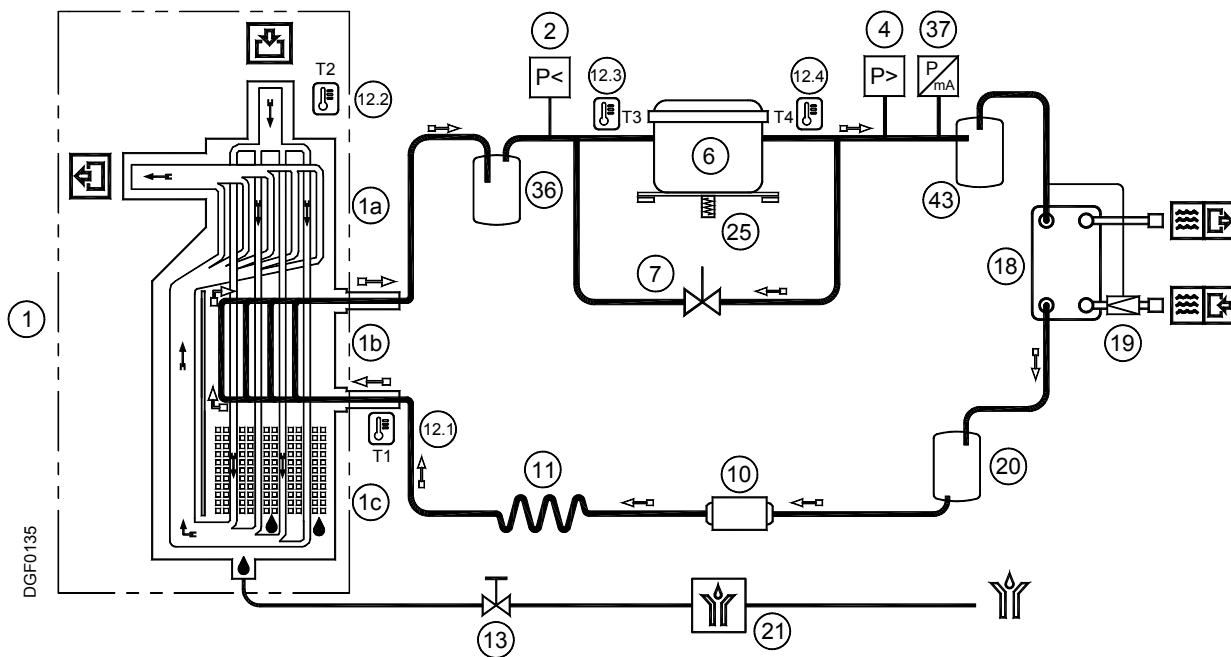

- | | |
|--|--|
| 1 Aluminium heat exchanger | 12.2 T2 Temperature probe – Air IN |
| a – Air/air heat exchanger | 12.3 T3 Temperature probe – Compressor suction |
| b – Air/refrigerant heat exchanger | 12.4 T4 Temperature probe – Compressor discharge |
| c – Condensate separator | 13 Condensate drain isolation valve |
| 2 Refrigerant pressure switch LPS (P<) | 18 Condenser (water-cooled) |
| 4 Refrigerant pressure switch HPS (P>) | 19 Cooling-water regulating valve (water-cooled) |
| 6 Refrigerating compressor | 20 Liquid collector |
| 7 Hot-gas bypass valve | 21 BEKOMAT condensate drain |
| 8 Condenser (air-cooled) | 25 Compressor crankcase heater |
| 9 Condenser fan (air-cooled) | 36 Liquid separator |
| 10 Filter dryer | 37 Refrigerant pressure transducer BHP |
| 11 Capillary tube | 43 Oil separator |
| 12.1 T1 Temperature probe – Dew point | |
| ➡ Compressed-air flow direction | ➡ Refrigerant gas flow direction |

11.5 Refrigerating compressor

The employed refrigerating compressors are constructed by leading manufacturers. The hermetically sealed construction is absolutely gastight. The integrated safeguard protects the compressor against overheating and excess current. The protection is automatically reset as soon as the nominal conditions are reached again.

11.6 Condenser (air-cooled)

The condenser is the component in which the gas coming from the compressor is cooled down, condensed and liquefied. Under no circumstances must the temperature of the ambient air exceed the nominal values. It is also important that the condenser unit is kept free from dust and other impurities.

11.7 Condenser (water-cooled)

The condenser is the component in which the gas coming from the compressor is cooled-down, condensed and liquefied.

The water inlet temperature must not exceed the nominal values. Likewise, a correct flow must be ensured. The water entering the condenser must be free from impurities.

11.8 Cooling-water regulating valve

The cooling-water controller serves to keep the condensation pressure or the condensation temperature constant during water cooling. When the dryer is switched off, the valve automatically blocks the cooling-water flow.



The condenser water regulating valve is an operating control device.

The closure of the water circuit from the pressure condenser water regulating valve cannot be used as a safety closure during service operations on the system.



ADJUSTMENT

The condenser water regulating valve is adjusted during the testing phase to a pre-set value that covers 90% of the applications. However, sometimes the extreme operating conditions of the dryer may require a more accurate calibration.

During start-up, a qualified technician should check the condensing pressure/temperature and if necessary adjust the valve by using the screws on the valve itself.

To increase the condensing temperature, turn the adjusting screws counter-clockwise; to lower it turn the screws clock-wise.

Water valve setting : R407C pressure 16 barg (± 0.5 bar)

11.9 Filter dryer

Despite controlled vacuuming, traces of moisture can accumulate in the refrigeration cycle. The filter dryer serves to absorb this moisture and to bond it.

11.10 Capillary tube

The capillary tube is a copper tube with a reduced diameter which is located between the condenser and the evaporator, serving as a restrictor to reduce the pressure of the refrigerant. The pressure reduction serves to reach an optimum temperature inside of the evaporator. The lower the outlet pressure at the capillary tube, the lower the evaporation temperature.

The length and the inner diameter of the capillary tube are exactly dimensioned to ensure the performance of the dryer. Settings or maintenance works are not required.

11.11 Aluminium heat exchanger

The heat exchanger module consists of an air/air heat exchanger, an air/refrigerant heat exchanger, and of a high-performance separator. The compressed air flows top-down through the heat exchanger. The large cross-sections of the flow passages cause low flow rates and low compressed-air losses. In the air/air heat exchanger, the heat exchange is effected in a reverse current. This guarantees maximum heat transfer. The heat transfer in the air/refrigerant heat exchanger also takes place in a reverse current. This allows full evaporation of the refrigerant. The high-performance separator ensures almost complete separation of the condensate. Maintenance of the high-performance separator is not required.

11.12 Hot-gas bypass valve

At partial load, the valve directly returns a part of the hot gas to the suction line of the refrigerating compressor. The evaporation temperature and the evaporation pressure remain constant.



ADJUSTMENT

The hot gas by-pass valve is adjusted during the manufacturing testing phase. As a rule no adjustment is required; anyway if it is necessary the operation must be carried out by an experienced refrigerating engineer.

WARNING

the use of 1/4" Schrader service valves must be justified by a real malfunction of the refrigerating system. Each time a pressure gauge is connected, a part of refrigerant is exhausted.

Without compressed air flow through the dryer, rotate the adjusting screw (position A on the drawing) until the following value is reached:

Hot gas setting : R407C pressure 4.5 barg (+0.1 / -0 bar)

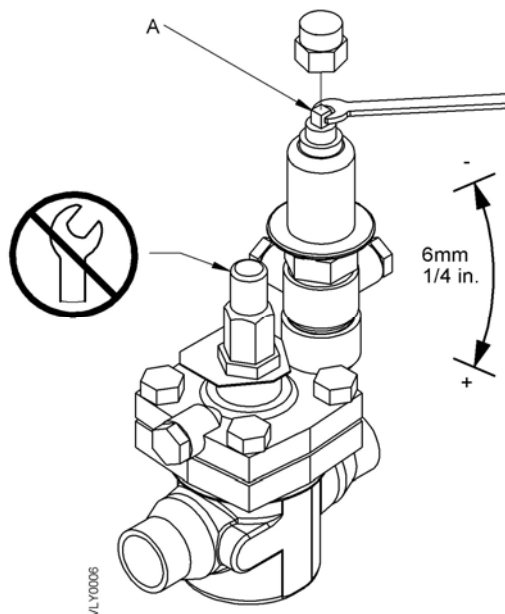

11.13 Refrigerant pressure switches LPS – HPS

To ensure the operational reliability and the protection of the dryer, a series of pressure switches are installed in the gas cycle.

LPS : Low-pressure guard on the suction side of the compressor, which is triggered when the pressure drops below the predetermined value. The values are reset automatically as soon as the nominal conditions are re-established.

Calibrated pressure : R 407 C Stop 1.7 barg - Restart 2.7 barg

HPS : The high-pressure control unit on the discharge side of the compressor is activated when the pressure exceeds the predetermined value. It has a manual reset button on the control itself.

Calibrated pressure : R 407 C Stop 30 barg - Manual reset (P<23 bar)

11.14 Compressor crankcase heater

During a longer downtime, the oil can intermix with the refrigerant. Therefore, "hydraulic shocks" may occur during the start-up of the compressor.

To prevent this, a heating resistor was installed in the housing of the compressor which maintains a corresponding oil temperature when the control panel is switched on and the compressor is idle.



Note!

The heating resistor needs to be switched on at least two hours prior to the start-up of the refrigerant compressor.

11.15 DMC 24 electronics (control unit compressed-air dryer)

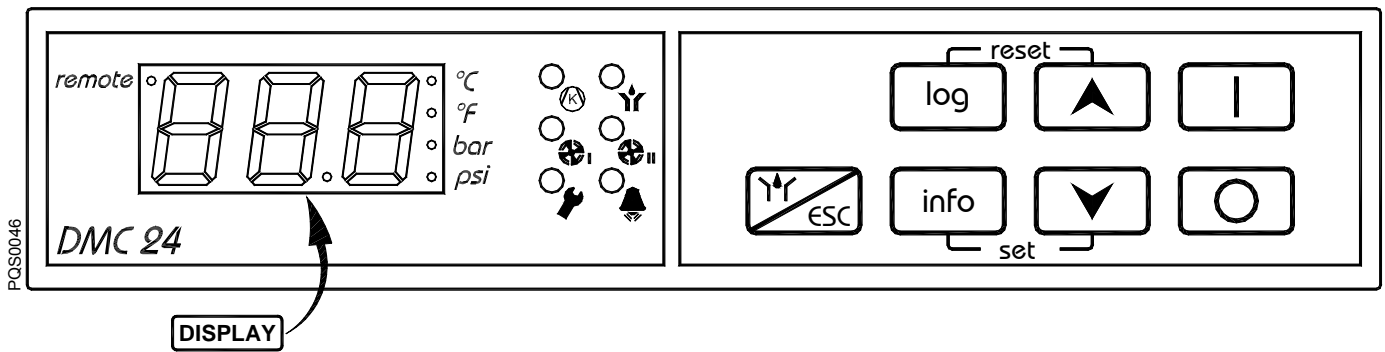

- LED**
- Compressor ON - green
 - Drain ON – green
 - Fan 1st stage ON – green
 - Fan 2nd stage ON – green
 - Service warning – orange
 - Alarm – red
 - remote* Remote control active
 - Temperature in °C
 - Temperature in °F
 - Pressure in bar(g)
 - Pressure in psi(g)

- BUTTON**
- ON
 - OFF
 - Increase
 - Decrease
 - Log
 - Info menu
 - Test button condensate drain / ESC
 - Instrument setting menu
 - Reset alarm and/or service

The DMC24 controls all operations, alarms and instrument settings of the dryer. The display and the LEDs indicate all operating conditions.

The LED shows that the compressor is ON.

Operation of the fans is indicated by the and LEDs.

During normal operation, the display shows the dew point temperature.

11.15.1 Switching the dryer on

When the unit is switched on, the display shows **OFF**.

The condensate drain test is always possible via the button.

- Press the button for at least two seconds to start the dryer: If the compressor was out of operation for a sufficient period of time, it will start immediately. If this is not the case, the display shows the countdown of the seconds until the compressor restarts and the LED flashes (max. delay five minutes).

11.15.2 Switching the dryer off

Press for at least two seconds from any menu. The display shows **OFF**.

11.15.3 Indication of the operating parameters – Info menu





The Info menu shows the dynamic operating parameters of the dryer.

When the dryer is ON and you are not in other menus, press for at least one second to access the Info menu.

Access to the Info menu is indicated on the display by the message **t I** (first parameter of the menu). Use the and arrows to move to the next or previous point. Press to have the value of the selected parameter displayed. Press again to return to the list of displayable parameters.



Press  to leave the Info menu (if, after a period of two minutes, no button is pressed, the menu is exited automatically).

Info	Description
T1	T1 – Temperature probe T1 – dew point
T2	T2 – Temperature probe T2 – Air IN
T3	T3 – Temperature probe T3 – Compressor suction
T4	T4 – Temperature probe T4 – Compressor discharge
HP	HP – Condensation pressure HP
HrS	HrS – Total number of operating hours
SrV	SrV – Hours to the next maintenance

Note: The temperatures are indicated in °C or °F (LED  °C or  °F is on).
 The pressure is indicated in bar(g) or psi(g)(LED  bar or  psi is on).
 The total operating hours and the hours until the next maintenance are indicated in the field 0...999 hours, and in thousand hours from 1.0 hours onwards (example: when the display shows 35, this means 35 hours and when the display shows 3.5, this means 3,500 hours).



11.15.4 Indication of a service warning

A service warning is an exceptional event and requires the attention of the operator/service technician. Such a warning will usually not stop the dryer (unless a high dew point parameter was adjusted to stop the dryer).

When a service warning is active, the  LED flashes. When the service warning was automatically reset, it has been stored and the  LED is continuously on.

In both cases the display shows the dew point temperature and the service warnings which are active or which are no longer active but not yet reset.

Service warnings are not automatically reset (except for *drn* which can be put on automatic reset).

To **RESET** the service warning, simultaneously press the   buttons for three seconds. Only the stored service warning will be reset. Service warnings which are still active continue to be indicated by the flashing  LED.



NOTE: the operator/service technician must check the dryer and eliminate the problem that led to the activation of the service warning.

Service warning	Description
PF 1	PF1 – Probe 1 failure: failure temperature probe 1
PF 2	PF2 - Probe 2 failure: failure temperature probe 2
PF 3	PF3 - Probe 3 failure: failure temperature probe 3
HdP	HdP – High dew point: dew point too high, higher than the adjusted HdA value.
LdP	LdP – Low dew point: dew point too low Setting T1< -1°C (30°F) delay five minutes / reset T1> 0°C (32°F)
drn	drn - Drain: failure condensate drain (opening of the DRN contact – see electric diagram) delay 20 minutes
SrV	SrV - Service : maintenance service time expired SrV
dt	dt – Outlet temperature: compressor outlet temperature (probe T4) outside the normal values but within the safety limits Setting T4> 90°C (194°F) delay three minutes / reset T4< 85°C (185°F)
HCP	HCP – High condensation pressure: condensation pressure (transformer HP) outside the normal values but within the safety limits Setting HP> 28barg (406psig) delay three minutes / reset HP< 25barg (363psig)

NOTE: when the dryer is switched on but no system pressure is applied, the *drn* drain trouble indication may appear.



11.15.5 Alarm indication

An alarm is an exceptional event which, to avert damage from to the machine and the operator, always leads to the disconnection of the dryer.

When the alarm is active, the  LED flashes. When the alarm was not automatically reset, it is stored and the  LED is on (in any case, the dryer remains OFF).

When the  LED flashes, the **OFF** message and the active alarms will appear in sequence on the display.

When the  LED is on, the **OFF** message and the alarms which triggered and which need to be reset will appear in sequence on the display.

The alarms are not automatically reset. To **RESET** an alarm, the  LED needs to be on and the   buttons must be pressed simultaneously for at least three seconds.

The dryer will not start automatically subsequent to the reset of the alarms.

NOTE: the operator/service technician must check the dryer and eliminate the problem that led to the activation of the alarm.





Alarm	Description
HP	HP – High pressure: the refrigerant high-pressure guard HPS has triggered (note: the pressure switch has a reset button)
LP	LP – Low pressure: the refrigerant low-pressure guard LPS has triggered
CO_n	CO _n - Compressor: the compressor protection and/or the reverse-phase protector RPP have triggered
FA_n	FA _n - Fan: the fan protection has triggered
Hdt	Hdt – High outlet temperature: compressor outlet temperature outside the safety limit Setting T4 > 100°C (212°F) delay one minute / reset T4 < 90°C (194°F)
ICE	ICE - ICE / Icing: Temperature in the exchanger (probe T1) is too low and leads to icing of the condensate. Setting T1 < -3°C (27°F) delay one minute / reset T1 > 0°C (32°F)
LCP	LCP – Low condensation pressure: condensation pressure too low
PF4	PF4 – Probe 4 failure: failure probe 4
PFP	PFP – Probe pressure failure: failure condensation pressure transducer BHP

Technical description

11.15.6 Display of the alarm memory – log menu

The log menu includes a list of the last 10 alarms (only alarms, no service warnings). They appear in chronological order (LIFO logic).

When the dryer is ON or OFF, and when you are not in another menu, press the  button for at least one second to access the log menu.

The access to the log menu is confirmed on the display by the message **L01** (L01) (first parameter of the menu). Use the  and  arrows to move to the next or previous point (L01 ... L10). Press  to have the selected log value displayed. Alternatively, the parameter that triggered the alarm and the operating hours of the machine at the moment of the alarm activation are indicated. Press  again to return to the log list.

Press  to leave the log menu (if, after a period of two minutes, no button is pressed, the menu is exited automatically).

11.15.7 Control of the dryer via remote control

The DMC24 can easily be controlled via two digital inputs which are connected with terminals 1, 2 and 3 (see electric diagram).

Close the contact between terminals 2 and 3 to enable the remote control. The *remote*  LED lights up and it is no longer possible to switch the dryer on or off from the local control panel (the condensate drain test is possible and you have access to the info and log menus).

When the contact between terminals 2 and 3 is closed, close the second contact between terminals 1 and 2 to switch on the dryer. Open the contact between terminals 1 and 2 to switch off the dryer.



Only use potential-free contacts that are suitable for low voltage. Ensure the sufficient insulation of potentially dangerous voltage-carrying components.



CAUTION!

Automatic restart / remote control ON/OFF. The unit may start up without any active influence!

The user will be responsible for the installation of proper protections for possible sudden power restoration to the dryer.

11.15.8 Operation of the potential-free failure/alarm contact

The DMC24 is equipped with a potential-free contact to indicate failures or alarm conditions.

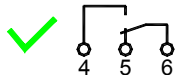

Dryer is switched on, no service warning and no alarm (active and not yet reset) indicated.

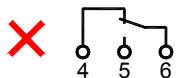

Dryer is off or a service warning or alarm (active and not yet reset) is indicated.

11.15.9 Connection to a serial line

The DMC24 can be connected to a serial monitoring line, a remote control or a notebook for the download of the alarm log files (memory).



For further information, please contact your retailer or your service centre.



11.15.10 How to change operating parameters – SETUP menu





The setup menu can be used to change the dryer’s operating parameters.



Only qualified personnel must be allowed to access to the setup menu. The manufacturer is not responsible for malfunctioning or failure due to modification to the operating parameters.

With dryer ON or OFF and not in other menus, simultaneously press buttons    for at least 5 seconds to enter the setup menu.

Access to the info menu is confirmed by message **ton** on the display (first parameter of menu). Use arrows  and  to move to following/previous one.

Keep  pressed to display the value of the selected parameter and use arrows  and  to change the value. Release the button  to confirm the value and skip to following parameter.

Press  to exit setup menu (if no button is pressed after 2 minutes the menu is exited automatically).

ID	Description	Limits	Resolution	Standard setup
ton	Ton – drain time ON : time ON condensate drain valve 00 = Electronic drainer installed	00 ... 20 sec	1 sec	00
toF	ToF - drain time OFF : pause time for condensate drain valve	1 ... 20 min	1 min	1
HdA	HdA - High DewPoint Alarm : Alarm threshold for a high DewPoint (the alarm disappears when the temperature drop 1°C / 2°F below alarm point)	0.0...25.0 °C or 32 ... 77 °F	0.5 °C or 1 °F	20 or 68
Hdd	Hdd - High DewPoint Delay : high DewPoint alarm enable delay	01 ... 20 minutes	1 min	15
HdS	HdS - High DewPoint alarm STOP : select if high DewPoint alarm stops dryer (YES) or does not stop dryer (nO)	YES ... nO	-	nO
SrL	SrV - Service Setting: setting of service warning timer. 00 = service warning timer disabled.	0.0 ... 9.0 (x 1000) hours	0.5 (x1000) hours	8.0
SCL	SCL - Scale: display scale of temperatures and pressure. (Note : setting °C = temperature in °C and pressure in bar; setting °F = temperature in °F and pressure in psi)	°C ... °F	-	°C
AS	AS - Auto Restart : automatic re-start at power supply. YES = at power supply dryer starts up again automatically (if it was ON) nO = at power supply dryer is always OFF	YES ... nO	-	nO
Ard	Ard - Auto Reset service drain : automatic reset of service drain YES = automatic reset at normal conditions nO = manual reset required	YES ... nO	-	YES
IPA	IPA - IP Address : selection of IP address to use in serial connection line	1 ... 255	1	1



AS = YES - CAUTION -

THE DRYER MAY POWER UP WITHOUT BEING ACTED UPON.

THE USER WILL BE RESPONSIBLE FOR THE INSTALLATION OF PROPER PROTECTIONS FOR POSSIBLE SUDDEN POWER RESTORATION TO THE DRYER.

11.16 Electronically level-controlled BEKOMAT condensate drain

The electronically level-controlled BEKOMAT condensate drain boasts a special condensate management which ensures that condensate is discharged safely and without an unnecessary loss of compressed air. This drain has a condensate collection container in which a capacitive sensor continuously monitors the liquid level. As soon as the switching level is reached, the capacitive sensor transmits a signal to the electronic control and a membrane solenoid valve opens to discharge the condensate. The BEKOMAT closes before compressed air emerges.



Note!

These BEKOMAT condensate drains were designed in particular for the operation in a **DRYPOINT RA** refrigeration dryer. The installation in other compressed-air processing systems or the replacement with another drain brand can lead to malfunction. The maximum operating pressure (see name plate) must not be exceeded!

Ensure that the upstream valve is open when the dryer starts operation.

To obtain detailed information regarding drain functions, troubleshooting, maintenance and spare parts, please read the installation and operating instructions of the BEKOMAT condensate drain.

12 Maintenance, troubleshooting, spare parts and dismantling

12.1 Checks and maintenance



Certified skilled personnel

Installation works must exclusively be carried out by authorised and qualified skilled personnel. Prior to undertaking any measures on the DRYPOINT® RA10800-13200 compressed-air refrigeration dryer, the certified skilled personnel⁴ shall read up on the device by carefully studying the operating instructions. The operator is responsible for the adherence to these provisions. The respective directives in force apply to the qualification and expertise of the certified skilled personnel.

For safe operation, the device must only be installed and operated in accordance with the indications in the operating instructions. In addition, the national and operational statutory provisions and safety regulations, as well as the accident prevention regulations required for the respective case of application, need to be observed during employment. This applies accordingly when accessories are used



Danger!

Compressed air!

Risk of serious injury or death through contact with quickly or suddenly escaping compressed air or through bursting and/or unsecured plant components.

Compressed air is a highly dangerous energy source.

Never work on the dryer when the system is under pressure.

Never direct the compressed-air outlet or condensate drain hoses at persons.

The user is responsible for the proper maintenance of the dryer. Non-observance of the instructions in the "Installation" and "Maintenance, troubleshooting, spare parts and dismantling" chapters leads to the expiration of the guarantee. Improper maintenance may result in dangerous situations for the personnel and/or the device.



Danger!

Supply voltage!

Contact with non-insulated parts carrying supply voltage involves the risk of an electric shock resulting in injuries and death.

Only qualified and skilled personnel are authorised to run electrically-operated devices. Prior to undertaking maintenance measures at the device, the following requirements must be met:

Make sure that the power supply is switched off and that the device is off and marked for maintenance measures. Please also ensure that the power supply cannot be re-established during the works.



Prior to carrying out maintenance works at the dryer, switch it off and wait for at least 30 minutes.



Caution!

Hot surfaces!

During operation, several components can reach surface temperatures of more than +60°C. There is the risk of burns.

All components concerned are installed inside of the closed housing. The housing must only be opened by certified skilled personnel.

Some components can reach high temperatures during operation. Avoid any contact until the system or the component has cooled down.

⁴ Certified skilled personnel are persons who are authorised by the manufacturer, with experience and technical training, who are well-grounded in the respective provisions and laws and capable of carrying out the required works and of identifying and avoiding any risks during the machine transport, installation, operation and maintenance. Qualified and authorised operators are persons who are instructed by the manufacturer regarding the handling of the refrigeration system, with experience and technical training, and who are well-grounded in the respective provisions and laws.



DAILY:

- Check whether the dew point indicated on the electronics is correct.
- Ensure that the condensate drain system functions properly.
- Make sure that the condenser is clean.

EVERY 200 HOURS OR MONTHLY



- Clean the condenser using an air jet (max. 2 bar / 30 psig) inside out. Make sure not to damage the aluminium lamellae of the cooling package.
- Finally, verify the operation of the device.



EVERY 1,000 HOURS OR ANNUALLY

- Verify all screws, clamps and connections of the electric system to make sure that they are fastened securely. Check the device for broken and ruptured cables or cables without insulation.
- Check the refrigeration cycle for signs of oil and refrigerant leaks.
- Measure the current strength and note it down. Ensure that the read values are within the permissible limit values, as indicated in the specification table.
- Check the hose lines of the condensate drain and replace them, if required.
- Finally, verify the operation of the device.



EVERY 8,000 HOURS

- Replace BEKOMAT(S) Service Unit(s)

12.2 Troubleshooting



Certified skilled personnel

Installation works must exclusively be carried out by authorised and qualified skilled personnel. Prior to undertaking any measures on the DRYPOINT® RA10800-13200 compressed-air refrigeration dryer, the certified skilled personnel shall read up on the device by carefully studying the operating instructions. The operator is responsible for the adherence to these provisions. The respective directives in force apply to the qualification and expertise of the certified skilled personnel.

For safe operation, the device must only be installed and operated in accordance with the indications in the operating instructions. In addition, the national and operational statutory provisions and safety regulations, as well as the accident prevention regulations required for the respective case of application, need to be observed during employment. This applies accordingly when accessories are used.



Danger!

Compressed air!

Risk of serious injury or death through contact with quickly or suddenly escaping compressed air or through bursting and/or unsecured plant components.

Compressed air is a highly dangerous energy source.

Never work on the dryer when the system is under pressure.

Never direct the compressed-air outlet or condensate drain hoses at persons.

The user is responsible for the proper maintenance of the dryer. Non-observance of the instructions in the "Installation" and "Maintenance, troubleshooting, spare parts and dismantling" chapters leads to the expiration of the guarantee. Improper maintenance may result in dangerous situations for the personnel and/or the device.



Danger!

Supply voltage!

Contact with non-insulated parts carrying supply voltage involves the risk of an electric shock resulting in injuries and death.

Only qualified and skilled personnel are authorised to run electrically-operated devices. Prior to undertaking maintenance measures at the device, the following requirements must be met:

Make sure that the power supply is switched off and that the device is off and marked for maintenance measures. Please also ensure that the power supply cannot be re-established during the works.



Prior to carrying out maintenance works at the dryer, switch it off and wait for at least 30 minutes.



Caution!
Hot surfaces!



During operation, several components can reach surface temperatures of more than +60°C. There is the risk of burns.

All components concerned are installed inside of the closed housing. The housing must only be opened by certified skilled personnel.

Some components can reach high temperatures during operation. Avoid any contact until the system or the component has cooled down.

FAULT





POSSIBLE REASON – SUGGESTED MEASURE

◆ The dryer does not start.	⇒ Check the power supply. ⇒ Check the electric cabling. ⇒ Fuse breakdown (see FU1/FU2/FU4 in the electric diagram) in the auxiliary circuit – replace it and check the proper operation of the dryer. ⇒ DMC24- The  LED is on – see the corresponding point.
◆ The refrigerating compressor does not work.	⇒ The internal guard was activated – wait 30 minutes and then recheck. ⇒ Check the electric cabling. ⇒ DMC24- Internal delay of the device – the display shows the seconds prior to the start-up. ⇒ DMC24- The  LED is on – see the corresponding point. ⇒ In the event that the compressor still does not work, replace it.
◆ The fan of the condenser does not work (air-cooled).	⇒ Check the electric cabling. ⇒ Power contactor of the fan is defective (see KV1/KV2 in the electric diagram) – replace it. ⇒ DMC24- The  LED is on – see the corresponding point. ⇒ Refrigerant gas loss – contact a specialist for refrigerating plants. ⇒ In the event that the fan still does not work, replace it.
◆ Dew point too high	⇒ Dryer does not start up – see the corresponding paragraph. ⇒ The T1 dew point sensor does not record the temperature properly – ensure that the sensor is pushed down to the bottom of the aluminium tube immersion sleeve. ⇒ The refrigerating compressor does not work – see the corresponding paragraph. ⇒ The room temperature is too high or the air change insufficient – ensure sufficient ventilation (air-cooled). ⇒ The inlet air is too hot – re-establish the operating conditions indic.on the name plate. ⇒ The inlet air pressure is too low - re-establish the operating conditions indic.on the name plate. ⇒ The inlet air throughput is higher than the throughput intended for operation – reduce the throughput - re-establish the operating conditions indic.on the name plate. ⇒ The condenser is dirty – please clean it (air-cooled). ⇒ The fan does not work – see the corresponding paragraph (air-cooling). ⇒ The cooling water is too hot - re-establish the operating conditions indic.on the name plate (water-cooled). ⇒ The cooling-water flow is insufficient - re-establish the operating conditions indic.on the name plate (water-cooled). ⇒ The dryer does not discharge condensate – see the corresponding paragraph. ⇒ The hot-gas bypass valve needs to be re-adjusted – contact a specialist for refrigerating plants to have the nominal calibration re-established. ⇒ Refrigerant gas loss – contact a specialist for refrigerating plants.



Maintenance, troubleshooting, spare parts and dismantling



◆ Dew point too low.	<ul style="list-style-type: none">⇒ The fan runs continuously – ensure perfect functioning of the fan power contactor (see KV1/KV2 on the electric diagram) and/or of the pressure transducer (see BHP on the electric diagram) – (air-cooled).⇒ The ambient temperature is too low – re-establish the conditions indic.on the name plate.⇒ The hot-gas bypass valve needs to be re-adjusted – contact a specialist for refrigerating plants to have the nominal calibration re-established.
◆ Extreme pressure drop in the dryer.	<ul style="list-style-type: none">⇒ The dryer does not discharge the condensate – see the corresponding paragraph.⇒ The pressure dew point is too low – the condensate is frozen, therefore, air cannot enter – see the corresponding paragraph.⇒ Make sure that the connection hoses are not pinched off.
◆ The dryer does not drain the condensate.	<ul style="list-style-type: none">⇒ The system pressure is too low and condensate is not discharged – re-establish the nominal conditions.⇒ Valve for the condensate drainage is closed – open the valve.⇒ Check the electric cabling.⇒ Pressure dew point too low – the condensate is frozen – see the corresponding paragraph.⇒ BEKOMAT-discharge unit does not work properly (see BEKOMAT manual).
◆ The dryer continuously discharges condensate.	<ul style="list-style-type: none">⇒ BEKOMAT discharge unit is dirty (see BEKOMAT manual).
◆ Water in the line.	<ul style="list-style-type: none">⇒ The dryer does not start – see the corresponding section.⇒ If installed: untreated air flows through the bypass group - close it.⇒ The dryer does not drain condensate – see the corresponding paragraph.⇒ The pressure dew point is too high – see the corresponding paragraph.
◆ The high-pressure switch HPS has triggered.	<ul style="list-style-type: none">⇒ Check which of the following reasons is responsible for the triggering:<ol style="list-style-type: none">1. The room temperature is too high or the air change insufficient – ensure sufficient ventilation (air-cooled).2. The condenser is dirty – please clean it (air-cooled).3. The fan does not work – see the corresponding paragraph (air-cooled).4. The cooling water is too hot – re-establish the operating conditions indic. on the name plate (water-cooled).5. Cooling-water flow insufficient - re-establish the operating conditions indic. on the name plate (water-cooled).⇒ Re-adjust the high-pressure switch, press the corresponding push button - check the dryer for proper operation/function.⇒ The HPS pressure failed or is defective – contact a specialist for refrigerating plants – replace the high-pressure switch.
◆ The LPS low-pressure switch was triggered.	<ul style="list-style-type: none">⇒ Refrigerant gas loss – contact a specialist for refrigerating plants.⇒ The low-pressure switch is automatically reset as soon as the nominal conditions are re-established – check the dryer for proper functioning.

◆ DMC24- LED is on.

- ⇒ At a flashing  LED: one or more alarms are active and the display shows **oFF** and the active alarms. When the  LED is lit: one or more alarms need to be reset and the display shows **oFF** and the alarms which are no longer active but which still need to be reset.
- ⇒ The alarms are indicated by the following messages:
1. **HP** : HPS pressure switch triggered (refrigerant high pressure) because the condensation pressure is too high – see the corresponding paragraph (NOTE: press the reset button on the HPS pressure switch when the problem is eliminated).
 2. **LP** : LPS pressure switch triggered (low pressure) because the refrigerant pressure is too low – see the corresponding paragraph.
 3. **Con** : Con – The electrical protection of the compressor has triggered (see Q1/QC1 on the electric diagram) – reset and check the perfect functioning of the dryer.
 4. **Con** : Con – during first startup - The main electrical connection of the compressor are connected incorrectly (see RPP on the electric diagram) – change the direction of rotation and interchange two phases. These modifications must only be carried out by a qualified electrician. DO NOT AVOID THE RPP PROTECTION: If the device is operated with the incorrect direction of rotation, the compressor will fail immediately. This will void the guarantee.
 5. **Con** : Con – one phase of power supply of dryer is missing (see RPP on the electric diagram) – restore the missing phase.
 6. **Con** : Con – Reverse Phase Protector (RPP) is faulty – replace it.
 7. **Con** : Con – If installed – Thermal protection inside the compressor tripped (see MC1 on wiring diagram) – wait 30 minutes and try again.
 8. **FAn** : FAn – The electrical protection of the fan has triggered (see QV1 on the electric diagram) – reset and check the perfect functioning of the dryer (air-cooled).
 9. **FAn** : FAn – The thermal protection in the fan has triggered (see MF on the circuit diagram – wait 30 minutes and retry (air-cooled).
 10. **Hdt** : Hdt – The outlet temperature protection of the compressor has triggered as a result of a very high temperature (probe T4) – see the corresponding paragraph.
 11. **ICE** : ICE – The temperature inside the exchanger (probe T1) is too low – the dew point is too low – see the corresponding paragraph.
 12. **LCP** : LCP – The condensation pressure is too low – see the corresponding paragraph.
 13. **PF4** : PF4 – Failure temperature probe T4 (compressor outlet) – check the electric cabling and/or replace the probe.
 14. **PF4** : PF4 – Failure pressure transducer BHP (condensation pressure) – check the electric cabling and/or replace the transformer.
- NOTE: The alarms need to be reset when the problem is eliminated (simultaneously press the   buttons for three seconds).

◆ The DMC24- LED is on.

- ⇒ When the  LED flashes, one or more service warnings are active. When the  LED is lit: one or more service warnings need to be reset. The display shows the dew point temperature and the service warning which is active or which is not yet reset.
- ⇒ The service warnings are indicated by the following messages:
1. **PF1** : PF1 – Failure temperature probe T1 (dew point) – check the electric cabling and/or replace the probe.
 2. **PF2** : PF2 – Failure temperature probe T2 (air IN) – check the electric cabling and/or replace the probe.
 3. **PF3** : PF3 – Failure temperature probe T3 (compressor intake) – check the electric cabling and/or replace the probe.
 4. **Hdp** : Hdp – Dew point too high (higher than the adjusted alarm value) – see the corresponding paragraph.
 5. **Ldp** : Ldp – Dew point too low – see the corresponding paragraph.
 6. **drn** : drn – The condensate drain does not work properly (condensate drain contact open) – see the corresponding paragraph. Delay 20 minutes.
 7. **SrV** : SrV - Service – maintenance notification time expired (parameter SrV) – carry out the scheduled maintenance and reset the hour meter.
 8. **dt** : dt – Compressor supply temperature too high (probe T4) – see the corresponding paragraph.
 9. **HCP** : HCP – Condensation temperature too high – see the corresponding paragraph.

NOTE: The services need to be reset when the problem is eliminated (simultaneously press the   buttons for at least three seconds).

- ◆ Compressor outlet temperature too high.
- ⇒ Find out the reason for the fault:
1. Excessive thermal load – re-establish the nominal conditions.
 2. The inlet air is too hot – re-establish the nominal conditions.
 3. The ambient air temperature is too high or the room ventilation insufficient – ensure sufficient ventilation.
 4. The condenser is dirty – please clean it.
 5. The fan does not work – see the corresponding section.
 6. The fan runs continuously – ensure perfect functioning of the power contactor of the fan (see KV1/KV2 on the electric diagram) and/or of the pressure transducer (see BHP on the electric diagram) – (air-cooled).
 7. The hot-gas bypass valve needs to be re-adjusted – contact a specialist to have the nominal calibration re-established.
 8. The temperature of the cooling water is too low – re-establish the nominal conditions (water-cooled).
 9. The adjusting valve for the cooling-water flow needs to be re-adjusted - contact a specialist to have the nominal calibration re-established (water-cooled).
 10. Refrigerant gas leak – contact a technician for refrigeration plants.
-

- ◆ Condensation pressure too high.
- ⇒ Find out the reason for the fault:
1. The ambient air temperature is too high or the air change insufficient in this area – ensure sufficient ventilation (air-cooled).
 2. The condenser filter is dirty – please clean or replace it (air-cooled).
 3. The fan does not work – see the corresponding section (air-cooled).
 4. The cooling water is too hot – re-establish the nominal conditions (water-cooled).
 5. The cooling-water flow is insufficient – re-establish the nominal conditions (water-cooled).
-

- ◆ Condensation pressure too low.
- ⇒ Find out the reason for the fault:
1. The fan runs continuously – ensure perfect functioning of the power contactor of the fan (see KV1/KV2 on the electric diagram) and/or of the pressure transducer (see BHP on the electric diagram).
 2. The ambient temperature is too low – re-establish the nominal conditions.
 3. Air flows through the condenser although the fan is switched off – protect the dryer against wind or external air flows (not caused by the fan of the dryer).
 4. The cooling-water temperature is too low – re-establish the nominal conditions (water-cooled).
 5. The adjusting valve for the cooling-water flow needs to be re-adjusted - contact a technician for refrigeration plants to have the nominal calibration re-established (water-cooled).
 6. Refrigerant gas leak – contact a technician for refrigeration plants.
 7. Compressor does not work – see specific point.
-

12.3 Recommended spare parts

Spare parts list is printed on a dedicated sticker applied inside the dryer. On this sticker each spare part is identified with its ID Number and related Spare Part Number. Here below the cross-reference table between ID Numbers and exploded drawings Ref. with their description and quantity installed in the dryers.

ID N.		DESCRIPTION	10800	13200
1 - 1.1		Heat exchanger replacement kit	6	6
2	LPS	Pressure switch	1	1
4	HPS	Pressure switch	1	1
6	MC1	Compressor	1	1
25	RC	Compressor crankcase heater	1	1
7		Hot gas by-pass valve	1	1
		Pilot valve	1	1
8		Condenser	1	1
9	MV1-MV2	Complete fan	2	2
10		Filter drier (cartridge)	1	1
12	BT1-BT4	Temperature probe	4	4
21	ELD	Electronic condensate drain	6	6
21.1		Electronic drain service unit	6	6
37	BHP	Pressure transducer	1	1
60	QS1	Main switch	1	1
	DMC24	DMC24 Display module	1	1
	DMC24MA	DMC24 Main module (air cooled setup)	1	1
		DMC24 Cable - main module to display	1	1
	QC1	Circuit breaker	1	1
	QV1 - QV2		2	2
	QC1	Auxiliary contact	1	1
	FU	Fuse kit	1	1
	KC1	Contactactor	1	1
	KC1	Auxiliary contact	3	3
	KHP	Relay	1	1
	KDR1-KDR2		2	2
	TF	Transformer	1	1
	RPP	Reverse phase protector	1	1

12.4 Maintenance works at the refrigeration cycle



Caution!
Refrigerant!

Maintenance and repair works at refrigeration systems must only be carried out by BEKO service technicians in accordance with the local provisions.
The total amount of refrigerant in the system must be collected for recycling purposes, resource recovery or disposal.

The refrigerant must not be discharged into the environment.

When delivered, the dryer is ready to operate and filled with a refrigerant of the R407C type.



Should you detect a refrigerant leak, please contact a BEKO service technician. Prior to any intervention, the room needs to be ventilated.

When the refrigeration cycle needs to be refilled, please also contact a BEKO service technician. You will find the refrigerant type and amount on the name plate of the dryer.

Properties of the refrigerant used:

Refrigerant	Chemical formula	MIK	GWP
R407C - HFC	R32/125/134a (23/25/52) CHF ₂ CF ₃ /CH ₂ F ₂ /CH ₂ FCF ₃	1000 ppm	1773.85

12.5 Dismantling the dryer

When the dryer is dismantled, all parts and operating materials related to the plant need to be disposed of separately.



Component	Material
Refrigerant	R407C, oil
Roof and supports	Structural steel, epoxy paint coat
Refrigerating compressor	Steel, copper, aluminium, oil
Aluminium heat exchanger	Aluminium
Condenser unit	Aluminium, copper, structural steel
Pipe	Copper
Fan	Aluminium, copper, steel
Valve	Brass, steel
BEKOMAT condensate drain	PVC, aluminium, steel
Insulant	Synthetic rubber without CFCs, polystyrene, polyurethane
Electric cable	Copper, PVC
Electric parts	PVC, copper, brass



We recommend observing the safety provisions in force for the disposal of each material type.

The refrigerant contains lubricating-oil droplets which are released by the compressor.

The refrigerant must not be discharged into the environment. It must to be sucked off from the dryer using a suitable device, and then needs to be supplied to a collection point.

13 Appendices

13.1 Dryer dimensions

13.1.1 Dimensions DRYPOINT RA 10800-13200 air-cooled

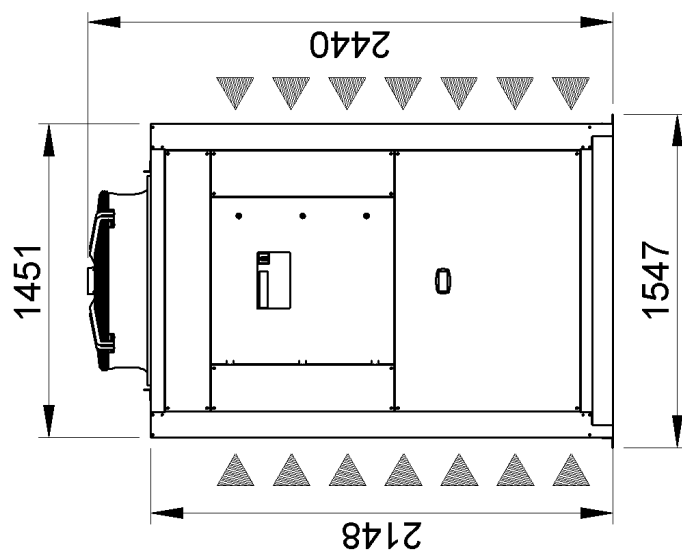
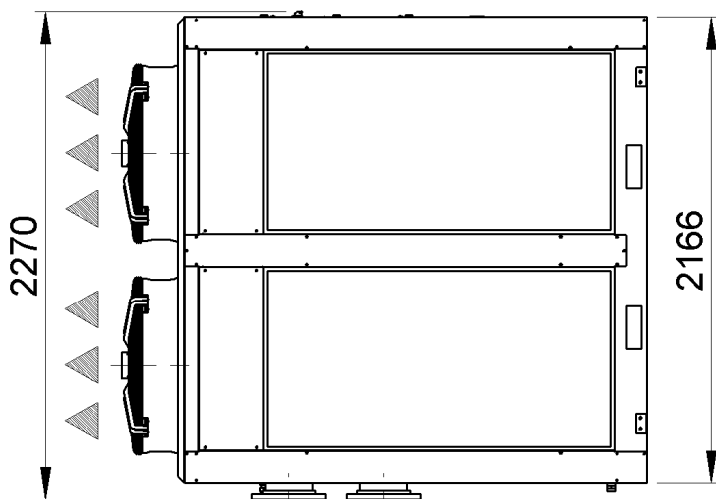
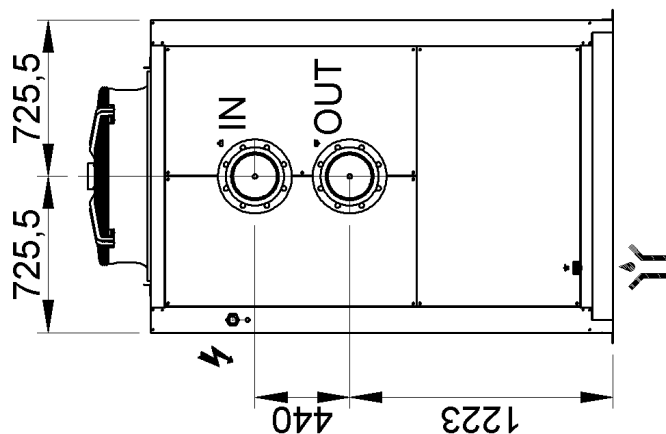

DMS0730

13.1.2 Dimensions DRYPOINT RA 10800-13200 water-cooled

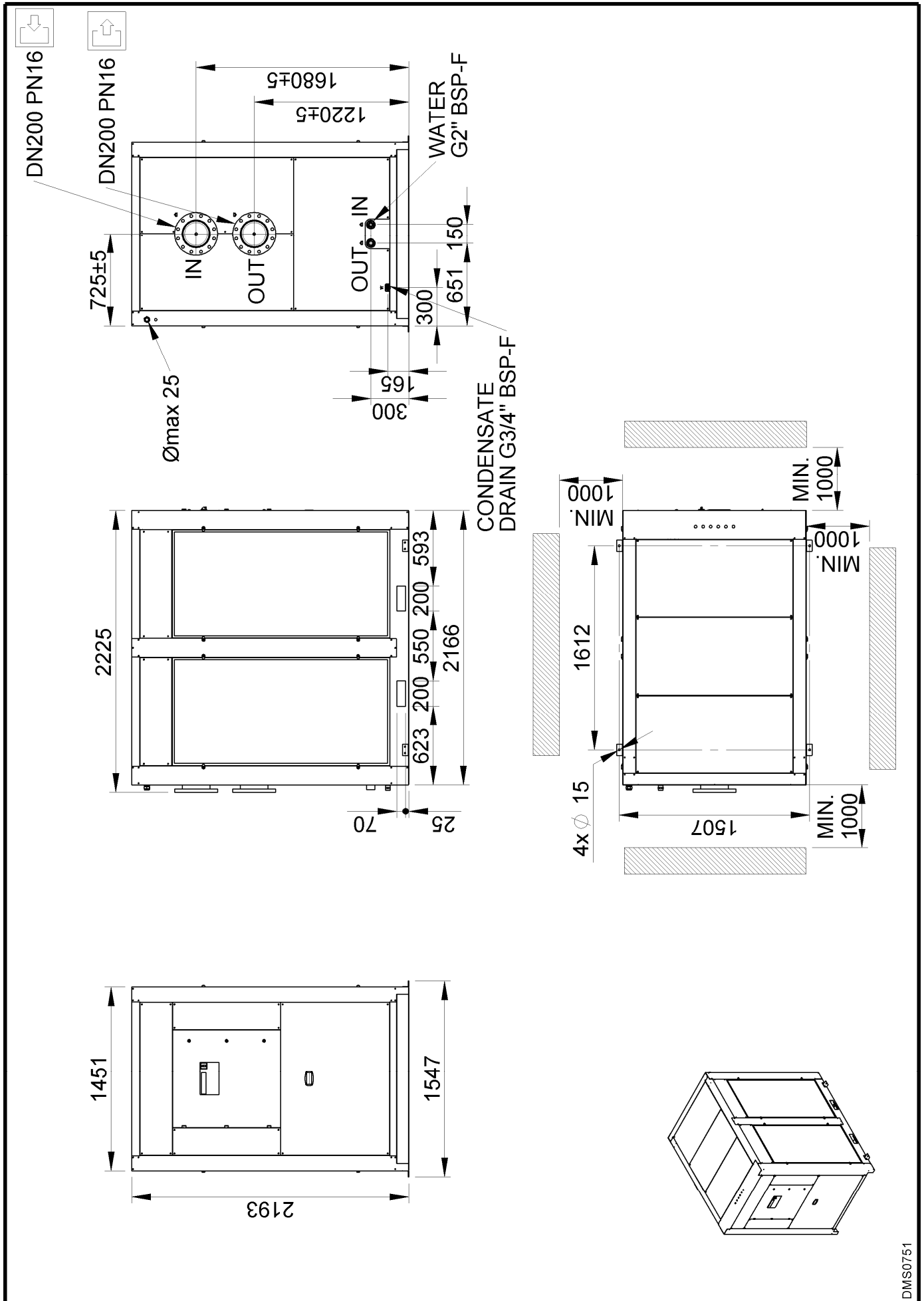

13.2 Exploded diagrams

13.2.1 Components of the exploded diagrams

1	Aluminium heat exchanger	36	Liquid separator
1.1	Insulation material	37	Refrigerant pressure transducer
2	Refrigerant pressure switch LPS	51	Front panel
4	Refrigerant pressure switch HPS	52	Back plate
6	Compressor	53	Right sidewall
7	Hot-gas bypass valve	54	Left sidewall
8	Condenser (air-cooled)	55	Cover
9	Condenser fan	56	Base plate
10	Filter dryer	57	Upper plate
11	Capillary tube	58	Carrier support
12	T1 temperature probe (dew point)	59	Support bracket
13	Condensate drain service valve	60	Control panel
17	Air dryer control	65	Condenser filter
18	Condenser (water-cooled)	66	QE door
19	Condenser water-regulating valve (water-cooled)	81	Adhesive label flow chart
20	Refrigerant reservoir (water-cooled)	83	Refrigerant service valve – high pressure
21	BEKOMAT drain	84	Refrigerant service valve – low pressure
22	Main switch		

13.2.2 Exploded diagram DRYPOINT RA 10800-13200 air-cooled

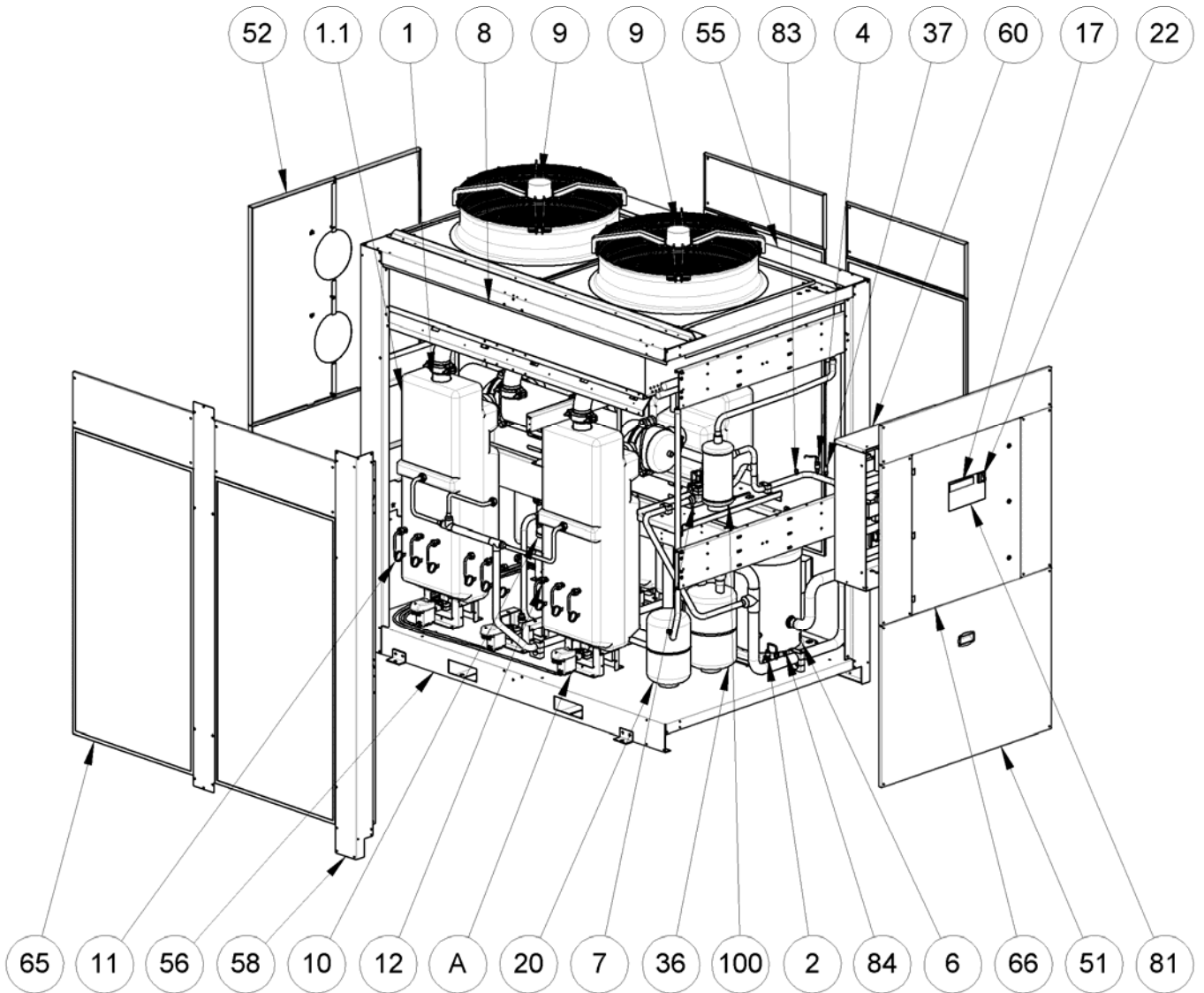

POS. "A" x6

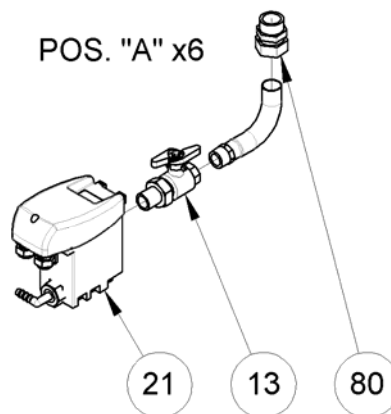

ESP0831

13.2.3 Exploded diagram DRYPOINT RA 10800-13200 water-cooled 1/2

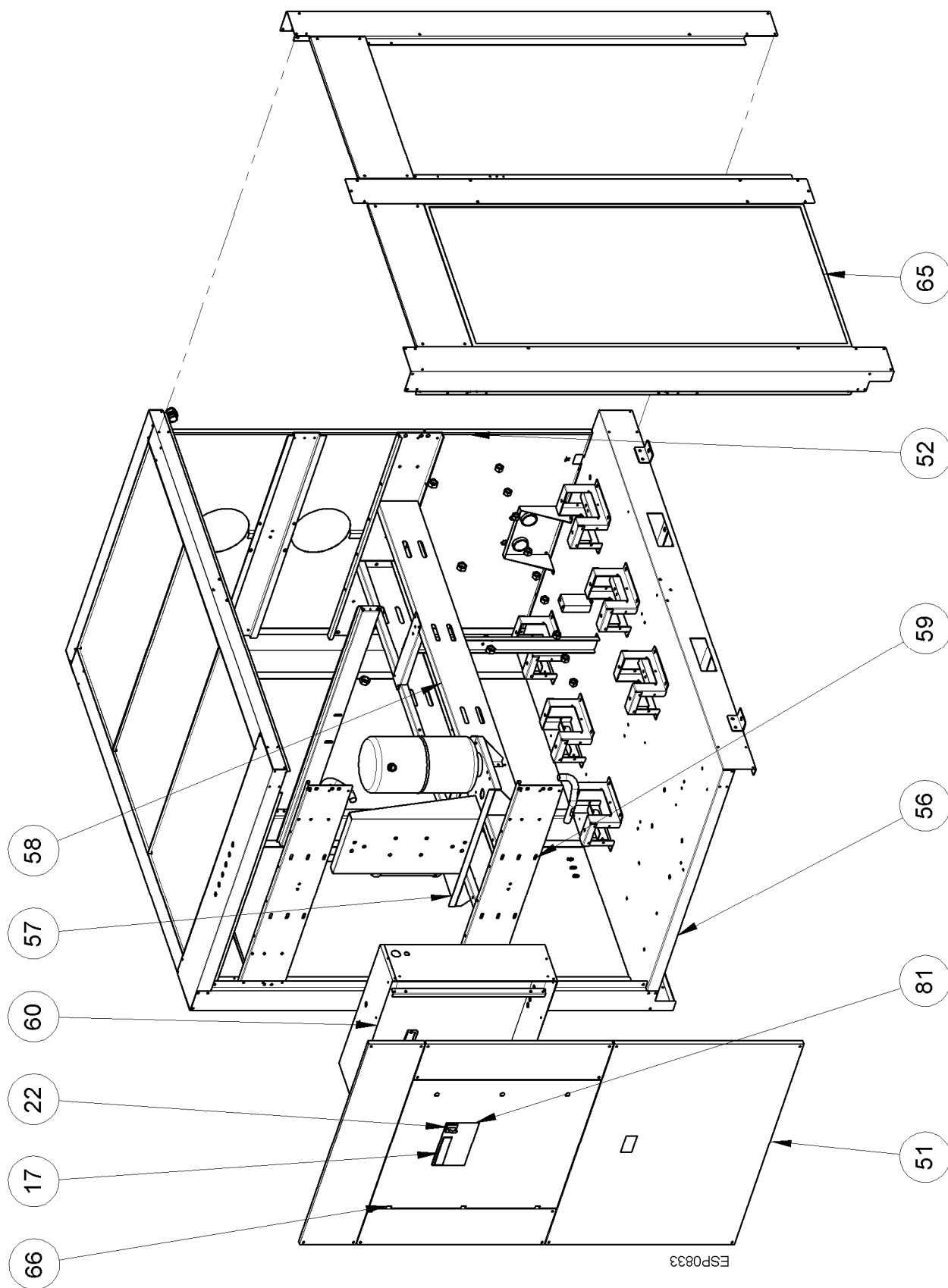

13.2.4 Exploded diagram DRYPOINT RA 10800-13200 water-cooled 2/2

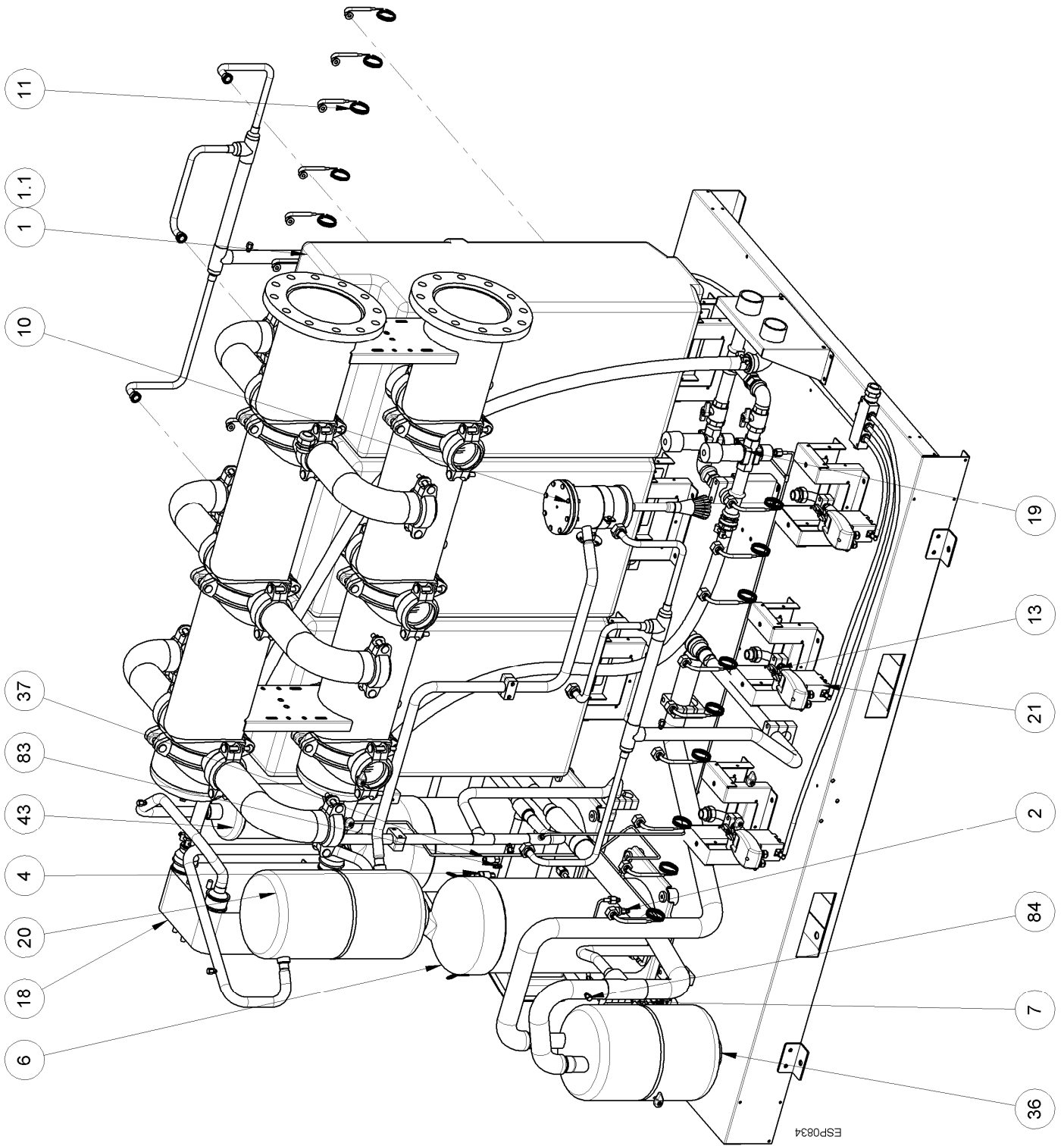

13.3 Electric diagrams

13.3.1 Electric diagrams – list of components

- MC** : Compressor
- MV** : Condenser fan
- DMC24RU** : DMC24 display module – air dryer control
- DMC24MA** : DMC24 main module – air dryer control
- BT1** : T1 Temperature probe – dew point
- BT2** : T2 Temperature probe – air IN
- BT3** : T3 Temperature probe – compressor suction
- BT4** : T4 Temperature probe – compressor discharge
- BHP** : Refrigerant pressure transducer
- HPS** : Pressure switch – compressor discharge side (HIGH PRESSURE)
- LPS** : Pressure switch – compressor suction side (LOW PRESSURE)
- ELD** : BEKOMAT drain
- EVD** : Time-controlled drain (not used)
- QS** : Main switch with locking device
- RC** : Compressor crankcase heater

- NT1** : Only air-cooled
- NT2** : Check the transformer connections with regard to the supply voltage
- NT3** : Jump, if not installed
- NT4** : Provided and cabled by the customer
- NT5** : Internal control
- NT6** : Time-controlled drain outlet (not used)
- NT7** : Only water-cooled

- BN** = BROWN **OR** = ORANGE
- BU** = BLUE **RD** = RED
- BK** = BLACK **WH** = WHITE
- YG** = YELLOW/GREEN **WH/BK** = WHITE/BLACK

13.3.2 Electric diagrams DRYPOINT RA 10800 - Sheet 1/8

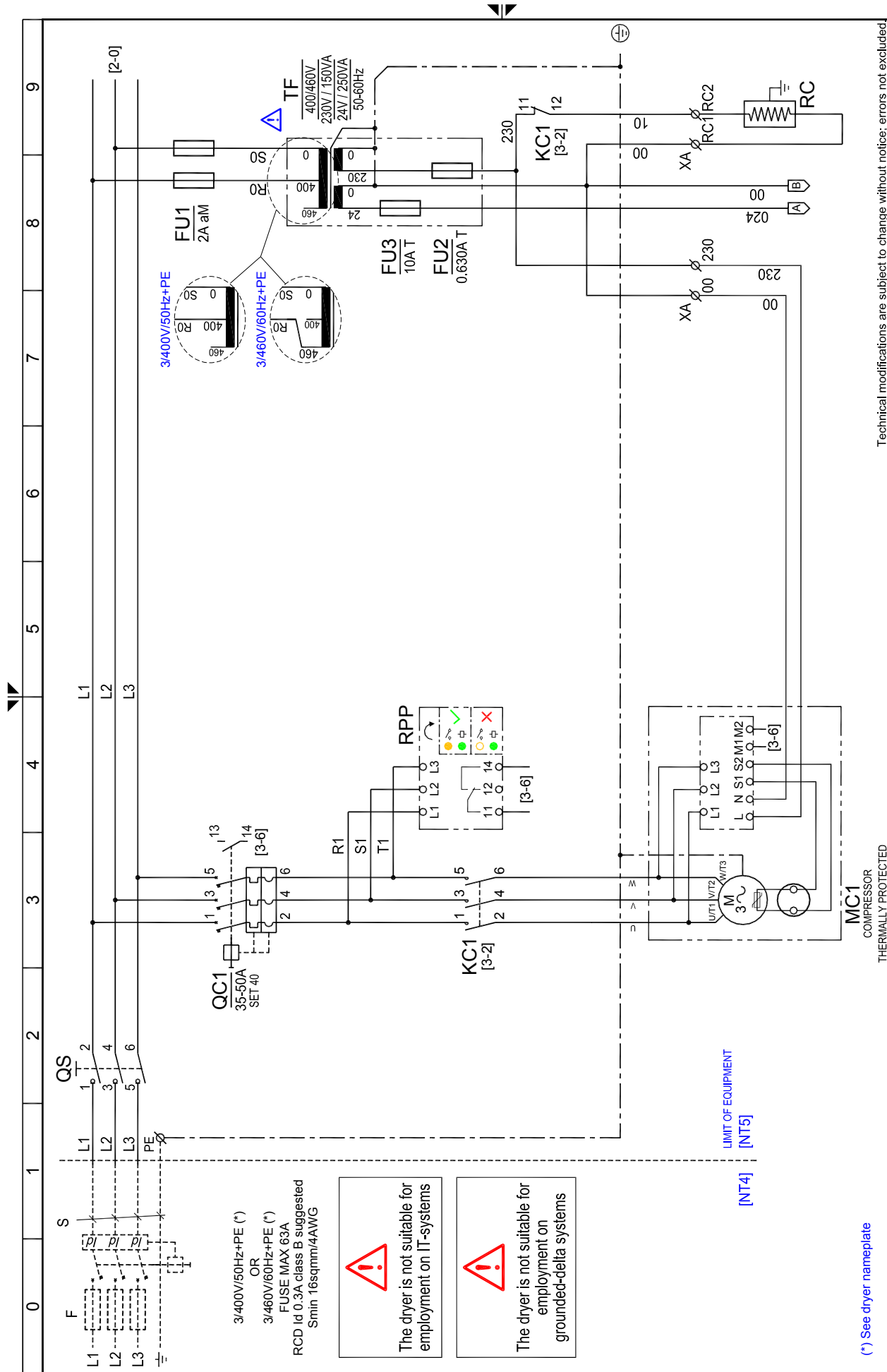

3/400V/50Hz+PE (*)
OR
3/460V/60Hz+PE (*)
FUSE MAX 63A
RCD Id 0.3A class B suggested
Smin 16sqmm/4AWG

The dryer is not suitable for
employment on IT-systems



The dryer is not suitable for
employment on
grounded-delta systems

(*) See dryer nameplate

Technical modifications are subject to change without notice; errors not excluded

Drawing no.: **FRACT5478QCD020** Rev. **00**
Note: **01** of **08**

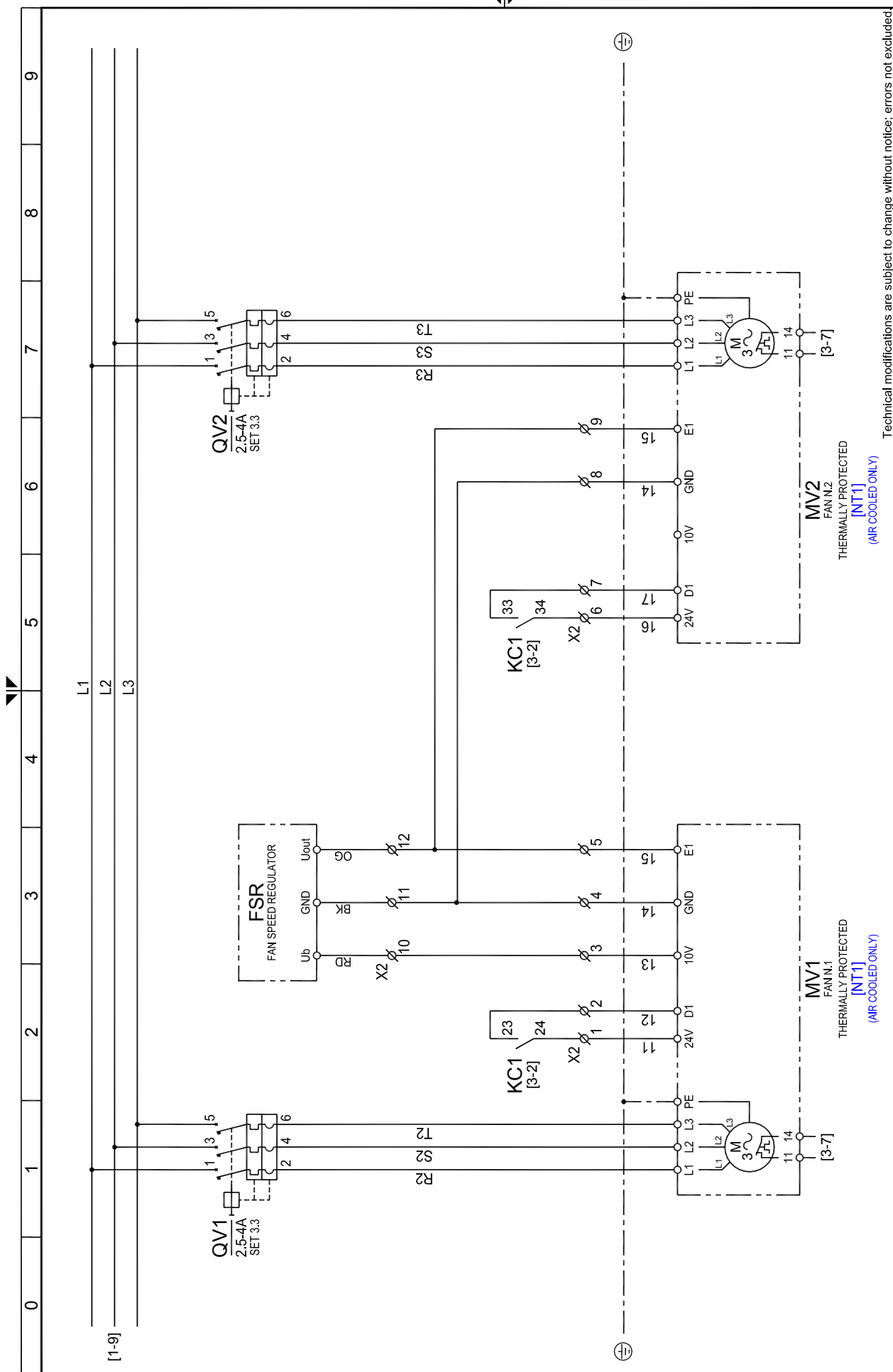
13.3.3 Electric diagrams DRYPOINT RA 10800 - Sheet 2/8



Technical modifications are subject to change without notice; errors not excluded

Drawing no. :

FRACT5478QCD020

Note :

Rev.

00

Sheet 02 of 08

13.3.4 Electric diagrams DRYPOINT RA 10800 - Sheet 3/8

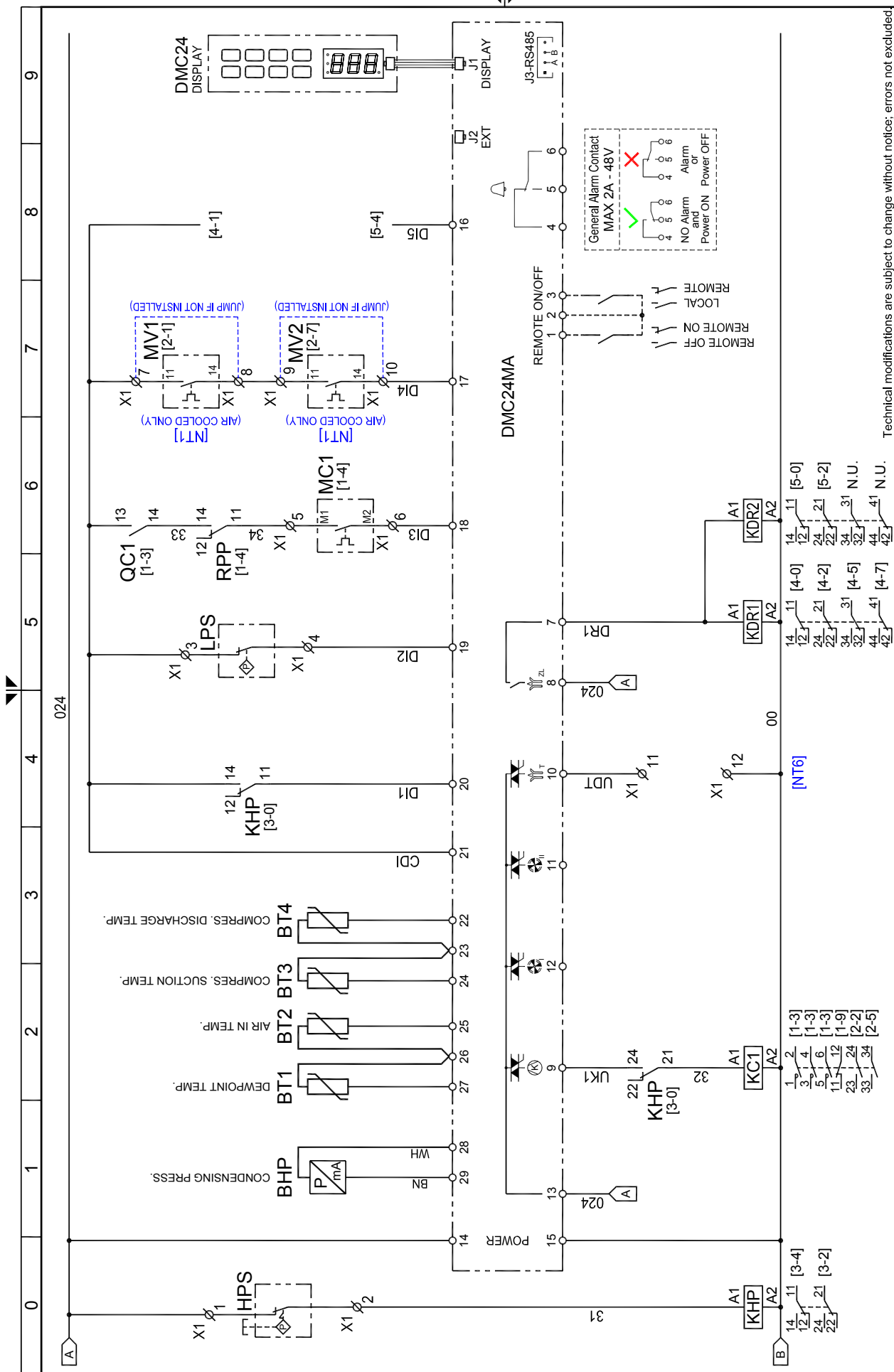

Technical modifications are subject to change without notice; errors not excluded

Rev. 00

FRACT5478QC020

Note :

Sheet 03 of 08

13.3.5 Electric diagrams DRYPOINT RA 10800 - Sheet 4/8

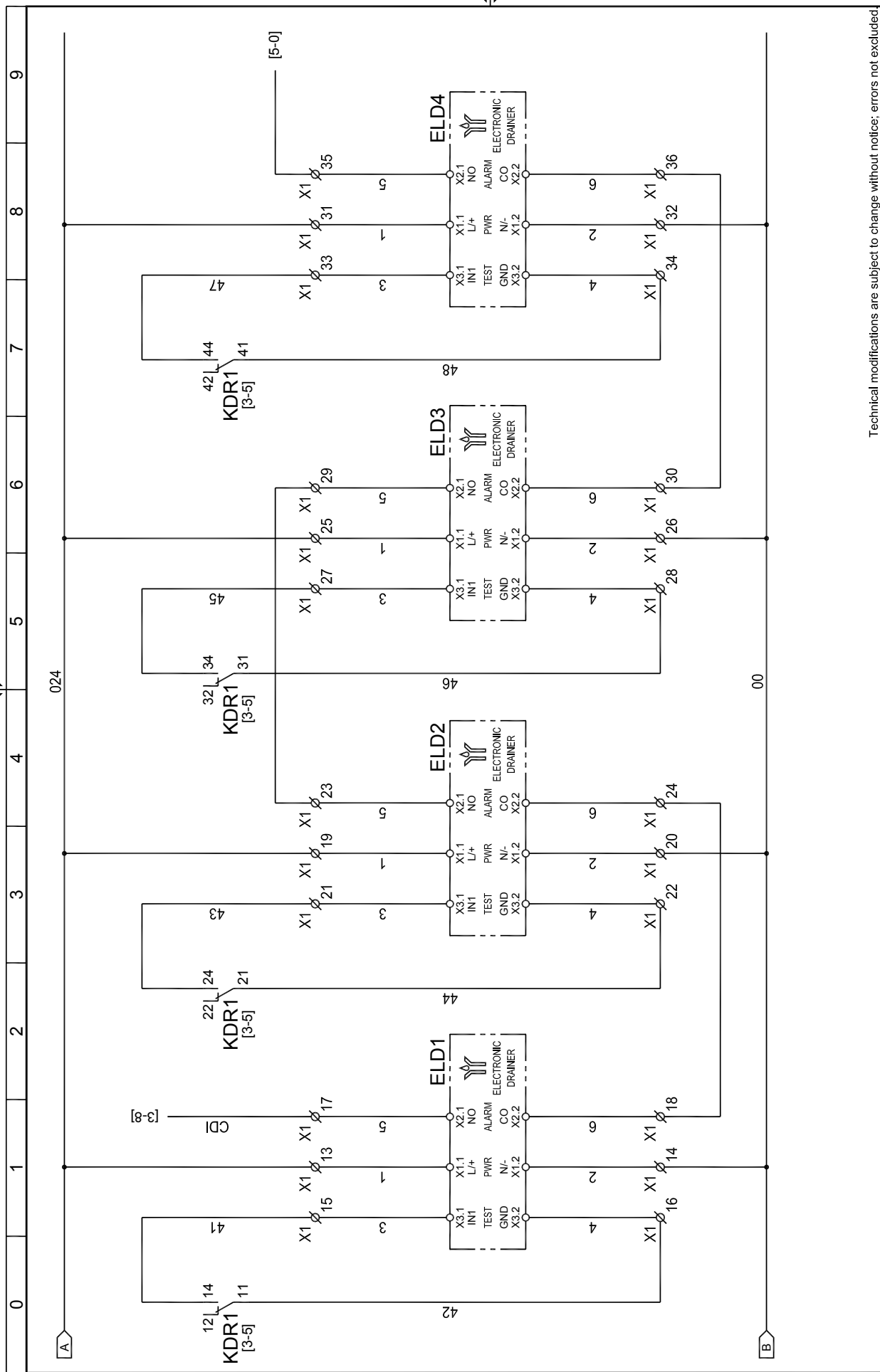

Technical modifications are subject to change without notice; errors not excluded

Drawing no. : FRACT5478QC020
 Rev. : 00
 Note : .
 Sheet 04 of 08

13.3.6 Electric diagrams DRYPOINT RA 10800 - Sheet 5/8

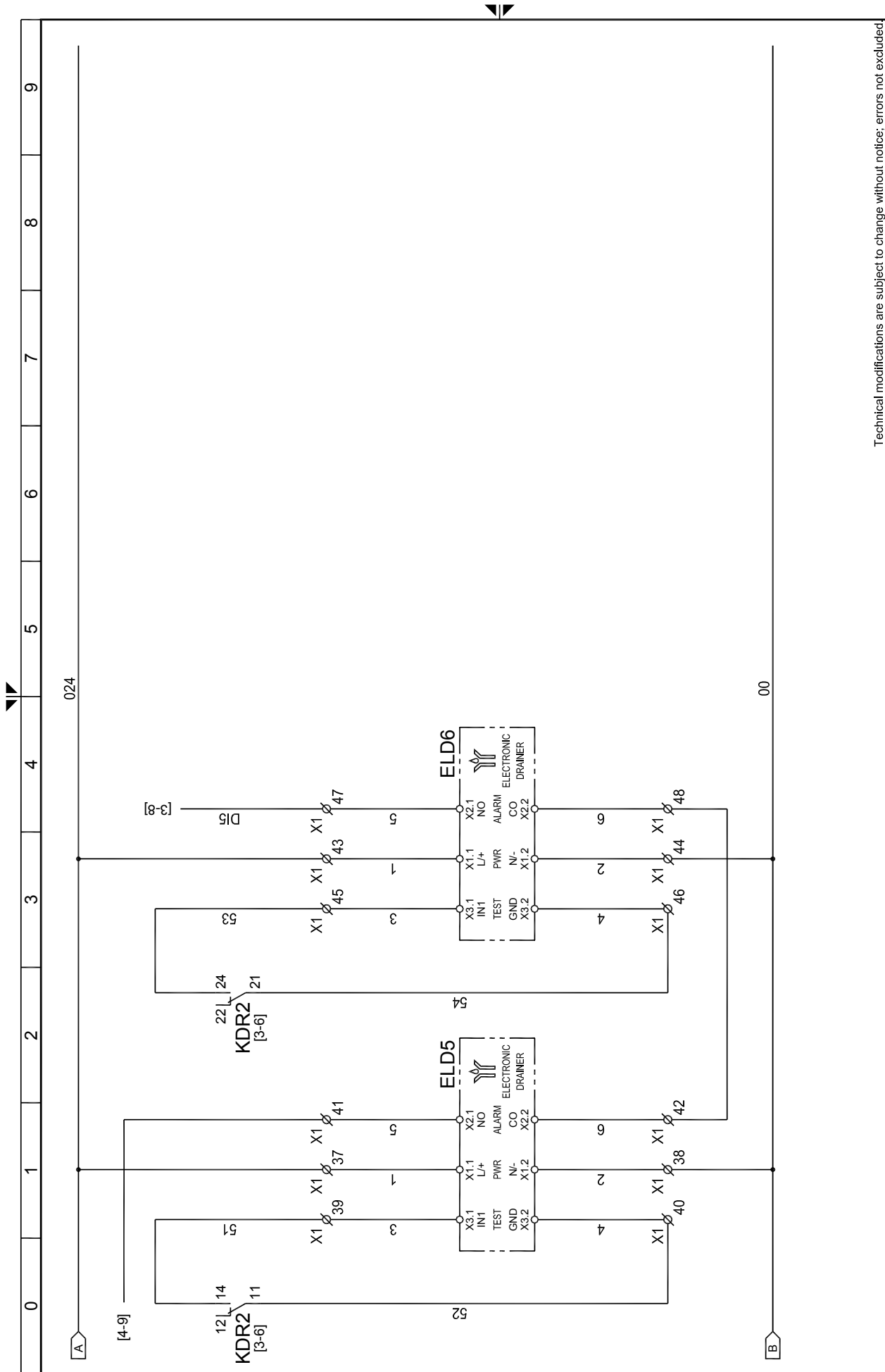

Technical modifications are subject to change without notice; errors not excluded

Drawing no. : FRACT5478QCD020

Rev. 00

Note : .

Sheet 05 of 08

13.3.7 Electric diagrams DRYPOINT RA 10800 - Sheet 6/8

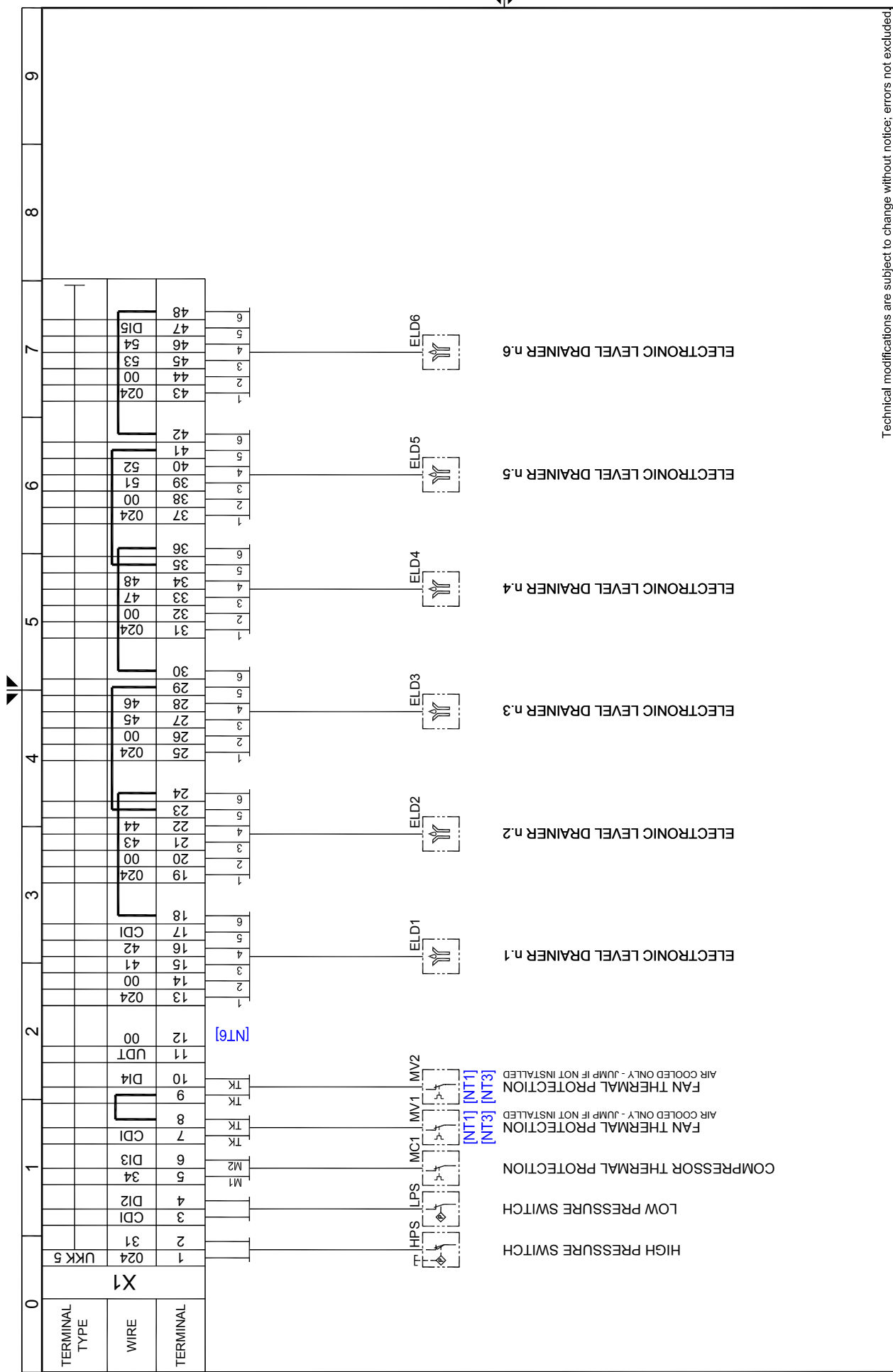

Technical modifications are subject to change without notice; errors not excluded

Drawing no. : FRACT5478QCD020

Rev. 00

Note : .

Sheet 06 of 08

13.3.8 Electric diagrams DRYPOINT RA 10800 - Sheet 7/8

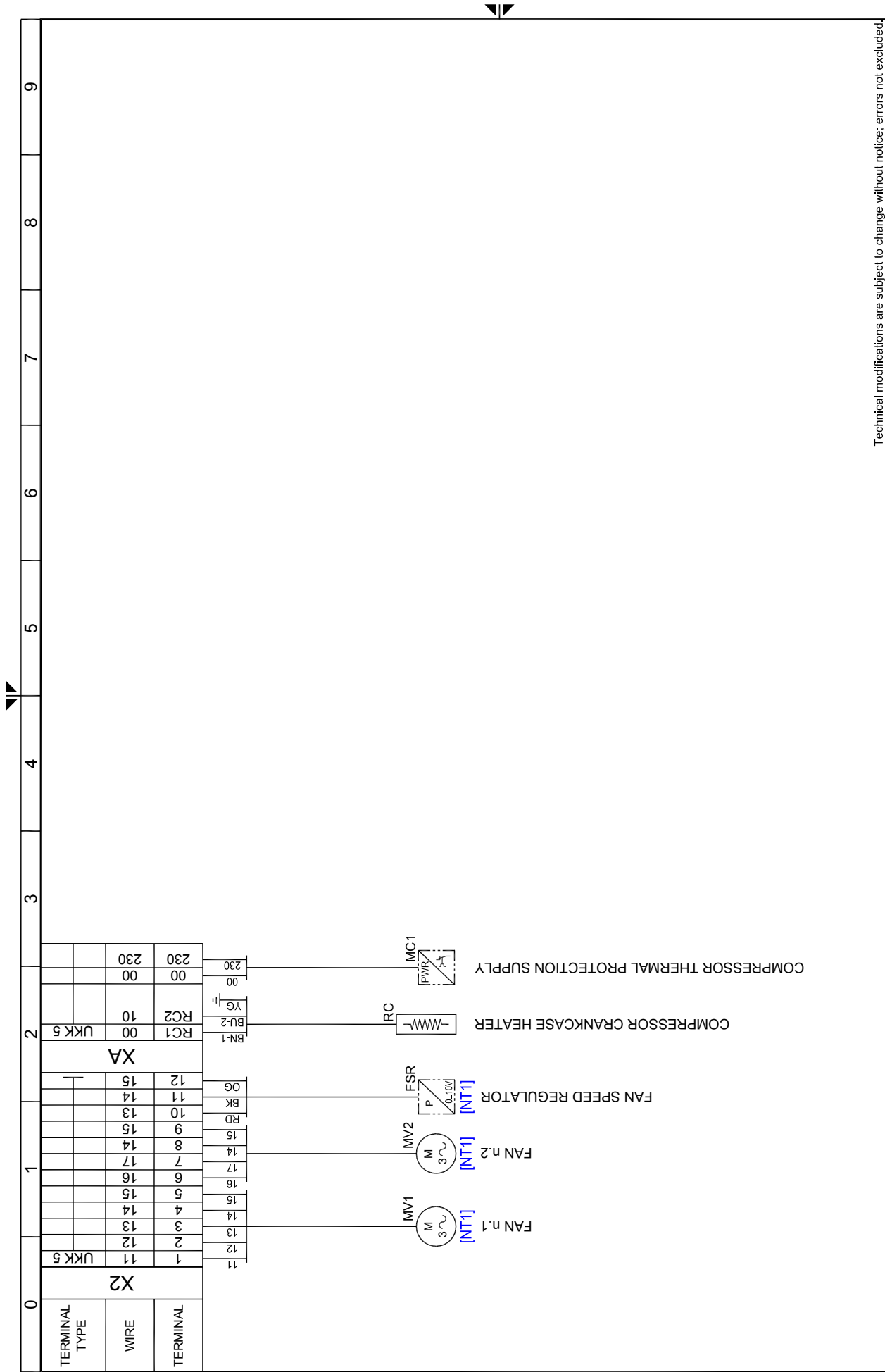

Technical modifications are subject to change without notice; errors not excluded

Drawing no.: **FRACT5478QCD020**
 Rev.: **00**
 Note: .
 Sheet **07** of **08**

13.3.9 Electric diagrams DRYPOINT RA 10800 - Sheet 8/8

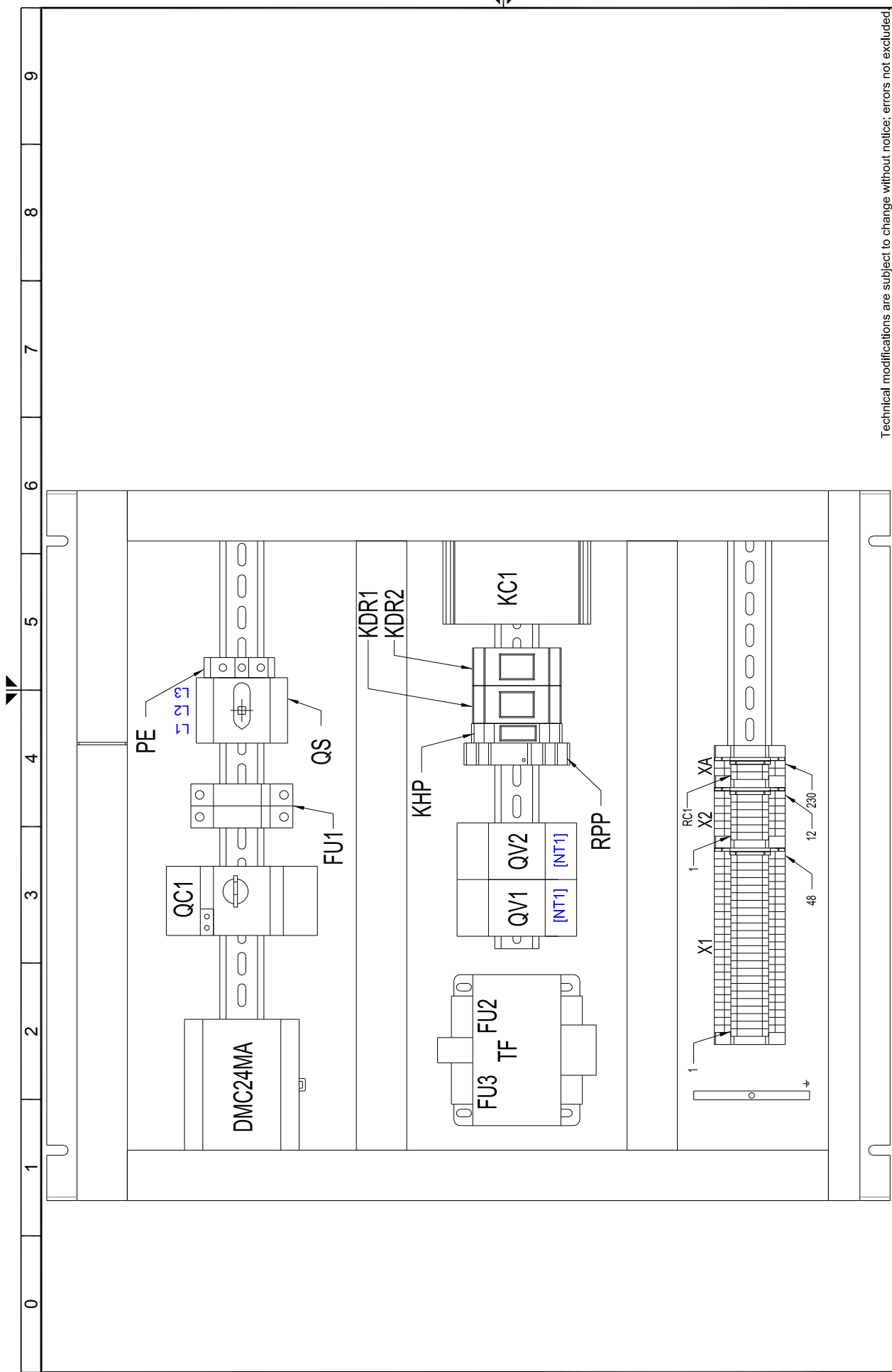

Drawing no. : **FRACT5478QCD020**
 Rev. : **00**
 Note : .
 Sheet **08** of **08**

13.3.10 Electric diagrams DRYPOINT RA 13200 - Sheet 1/8

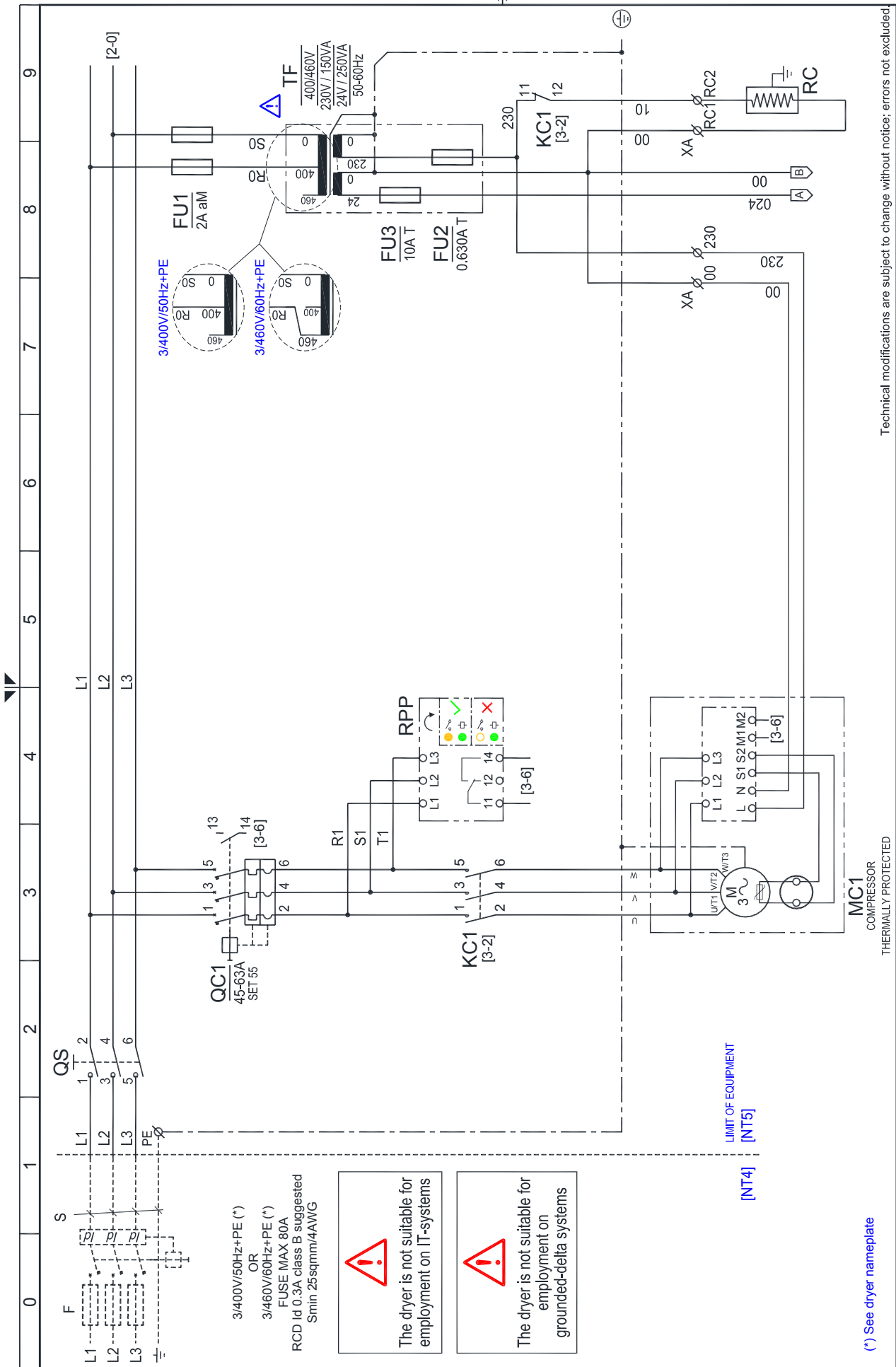

3/400V/50Hz+PE (*)
OR
3/460V/60Hz+PE (*)
FUSE MAX 80A
RCD Id 0.3A class B suggested
Smin 25sqmm/4AWG

!
The dryer is not suitable for employment on IT-systems

!
The dryer is not suitable for employment on grounded-delta systems

[NT4]
LIMIT OF EQUIPMENT
[NT5]

(*) See dryer nameplate

BEKO
BEKO TECHNOLOGIES GMBH
http://www.beko-technologies.com

Technical modifications are subject to change without notices; errors not excluded.

Drawing no.: BKRA5478QCD021
Rev. 00
Note: .
Sheet 01 of 08

13.3.11 Electric diagrams DRYPOINT RA 13200 - Sheet 2/8

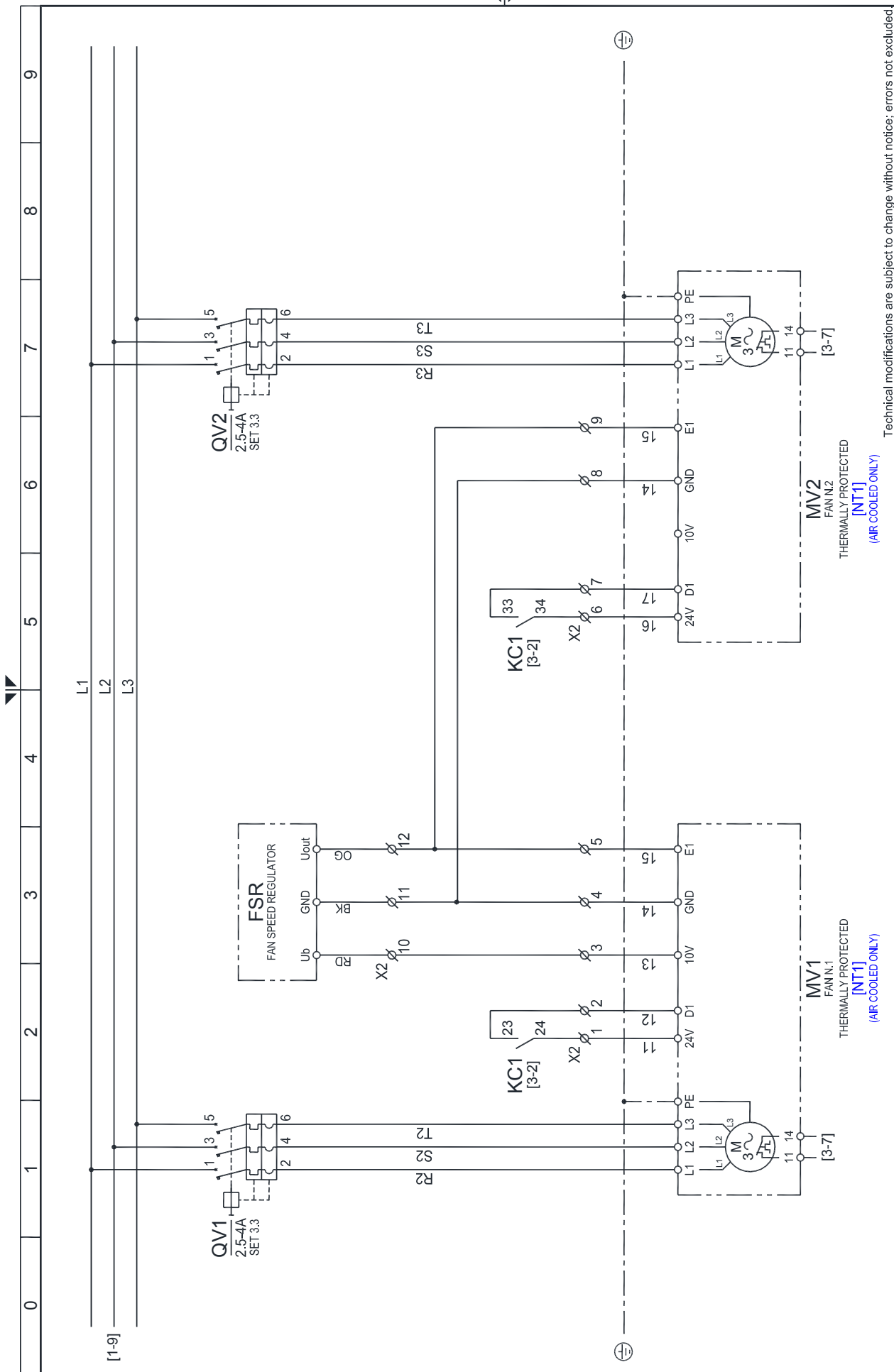

Technical modifications are subject to change without notice; errors not excluded.

Drawing no.: BKRA5478QCD021
 Rev. 00
 Note: .
 Sheet 02 of 08

BEKO TECHNOLOGIES GMBH
<http://www.beko-technologies.com>

13.3.12 Electric diagrams DRYPOINT RA 13200 - Sheet 3/8

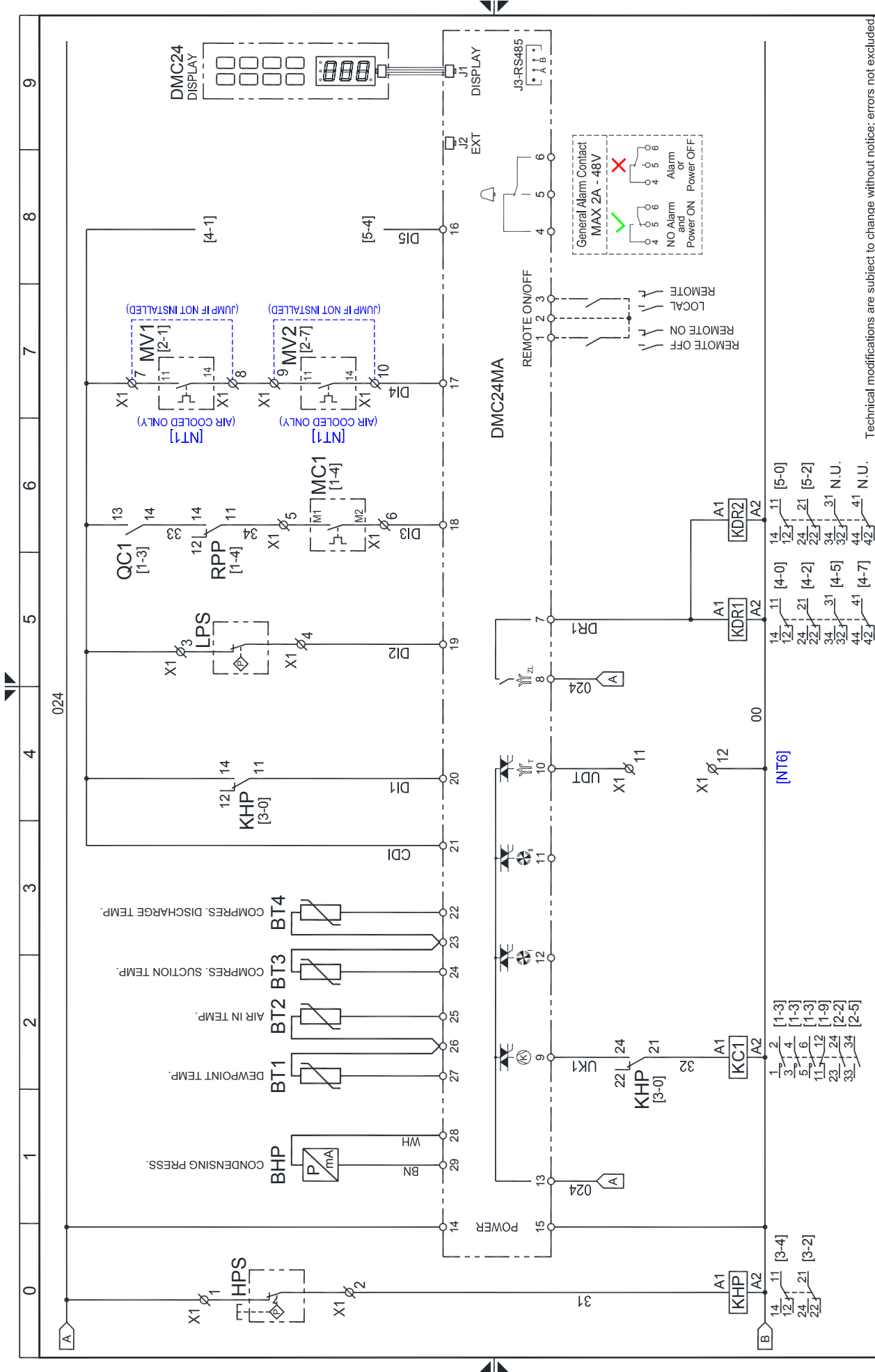

Technical modifications are subject to change without notice; errors not excluded

Rev. 00
 Drawing no.: BKRA5478QC021
 Note: -
 Sheet 03 of 08

BEKO TECHNOLOGIES GMBH
 http://www.beko-technologies.com

13.3.13 Electric diagrams DRYPOINT RA 13200 - Sheet 4/8

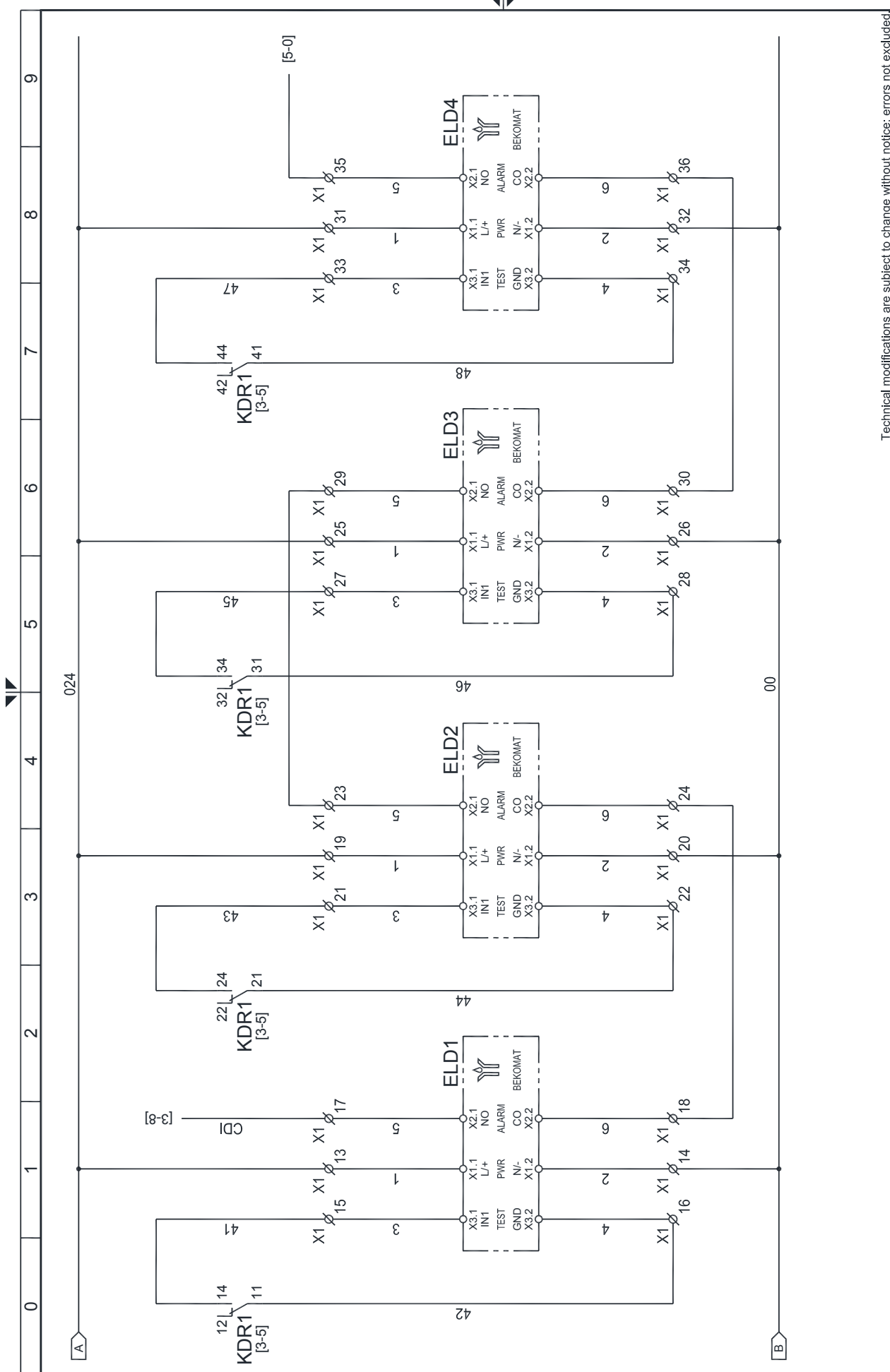

Technical modifications are subject to change without notice; errors not excluded.

Drawing no.: BKRA5478QCD021
 Rev. 00
 Note: .

BEKO TECHNOLOGIES GMBH
<http://www.beko-technologies.com>

Sheet 04 of 08

13.3.14 Electric diagrams DRYPOINT RA 13200 - Sheet 5/8

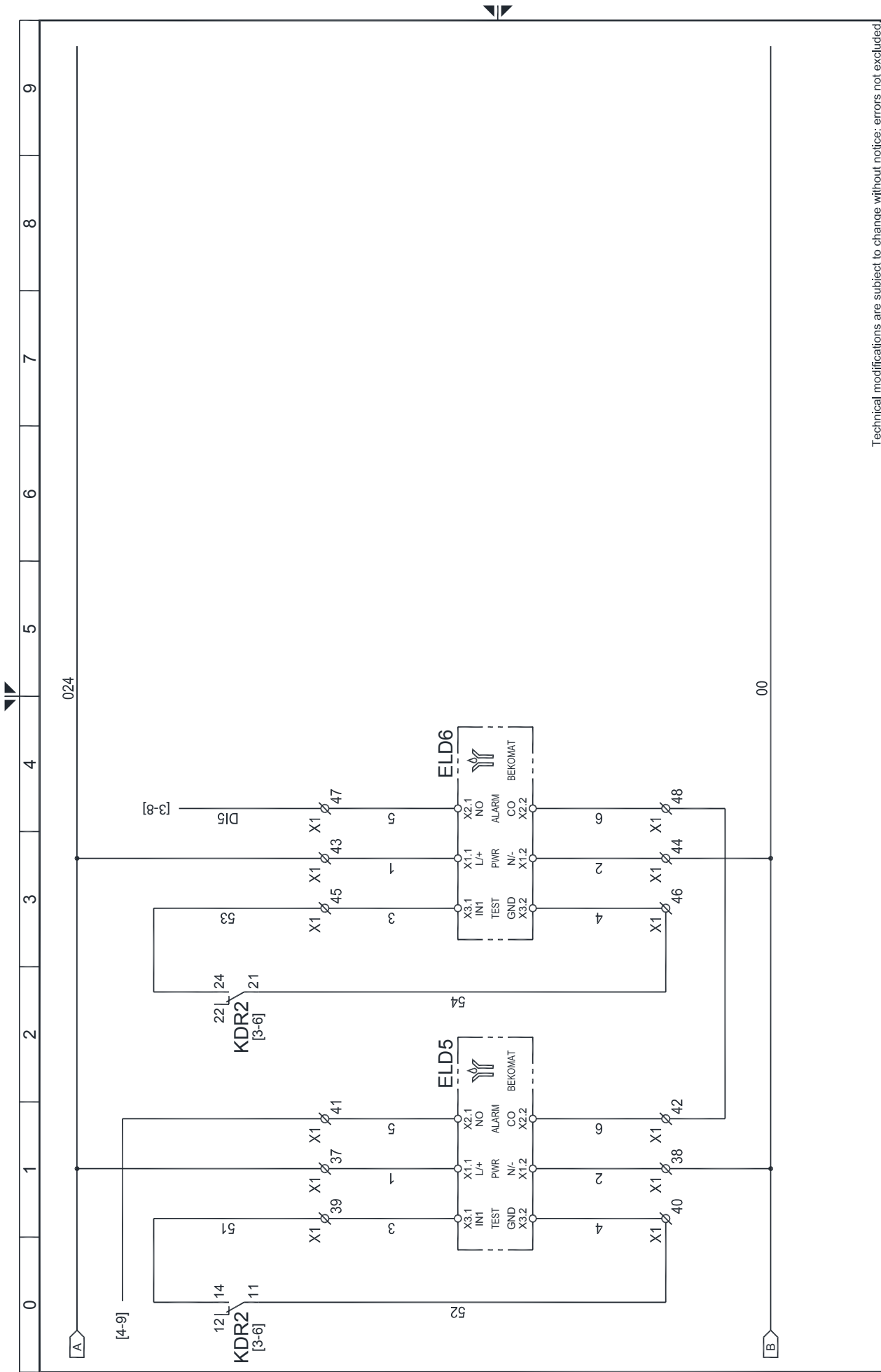

Technical modifications are subject to change without notice; errors not excluded.

Drawing no.: BKRA5478QCD021

Rev.: 00

Note: .

Sheet 05 of 08

13.3.15 Electric diagrams DRYPOINT RA 13200 - Sheet 6/8

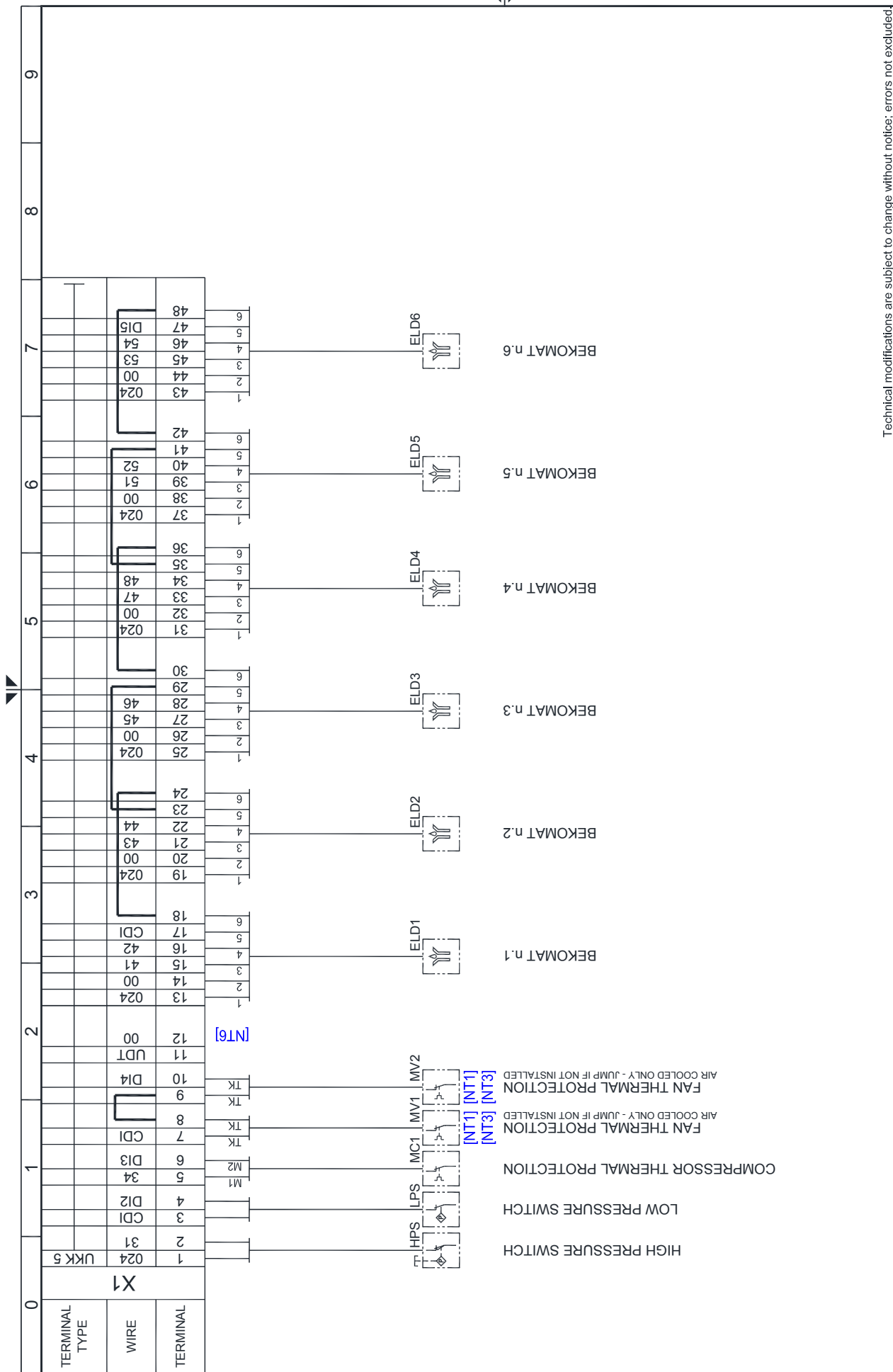

Technical modifications are subject to change without notice; errors not excluded.

Drawing no.: BKRA5478QCD021
 Rev.: 00
 Note: .
 Sheet 06 of 08

BEKO TECHNOLOGIES GMBH
[http:// www.beko-technologies.com](http://www.beko-technologies.com)

13.3.16 Electric diagrams DRYPOINT RA 13200 - Sheet 7/8

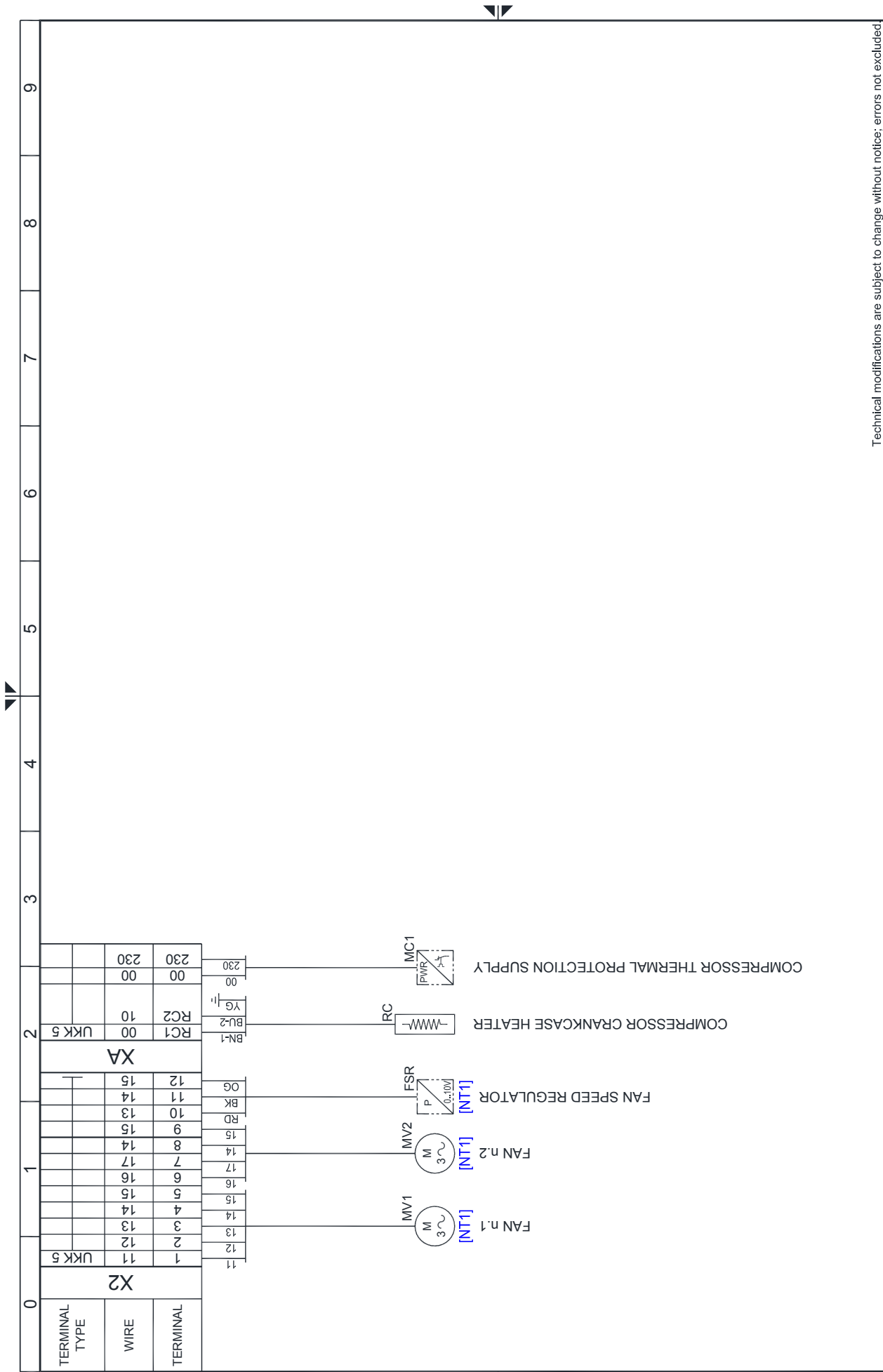

Technical modifications are subject to change without notice; errors not excluded

Drawing no.: **BKRA5478QCD021**
 Rev. **00**
 Note: -
 Sheet **07** of **08**

BEKO TECHNOLOGIES GMBH
<http://www.beko-technologies.com>



13.3.17 Electric diagrams DRYPOINT RA 13200 - Sheet 8/8

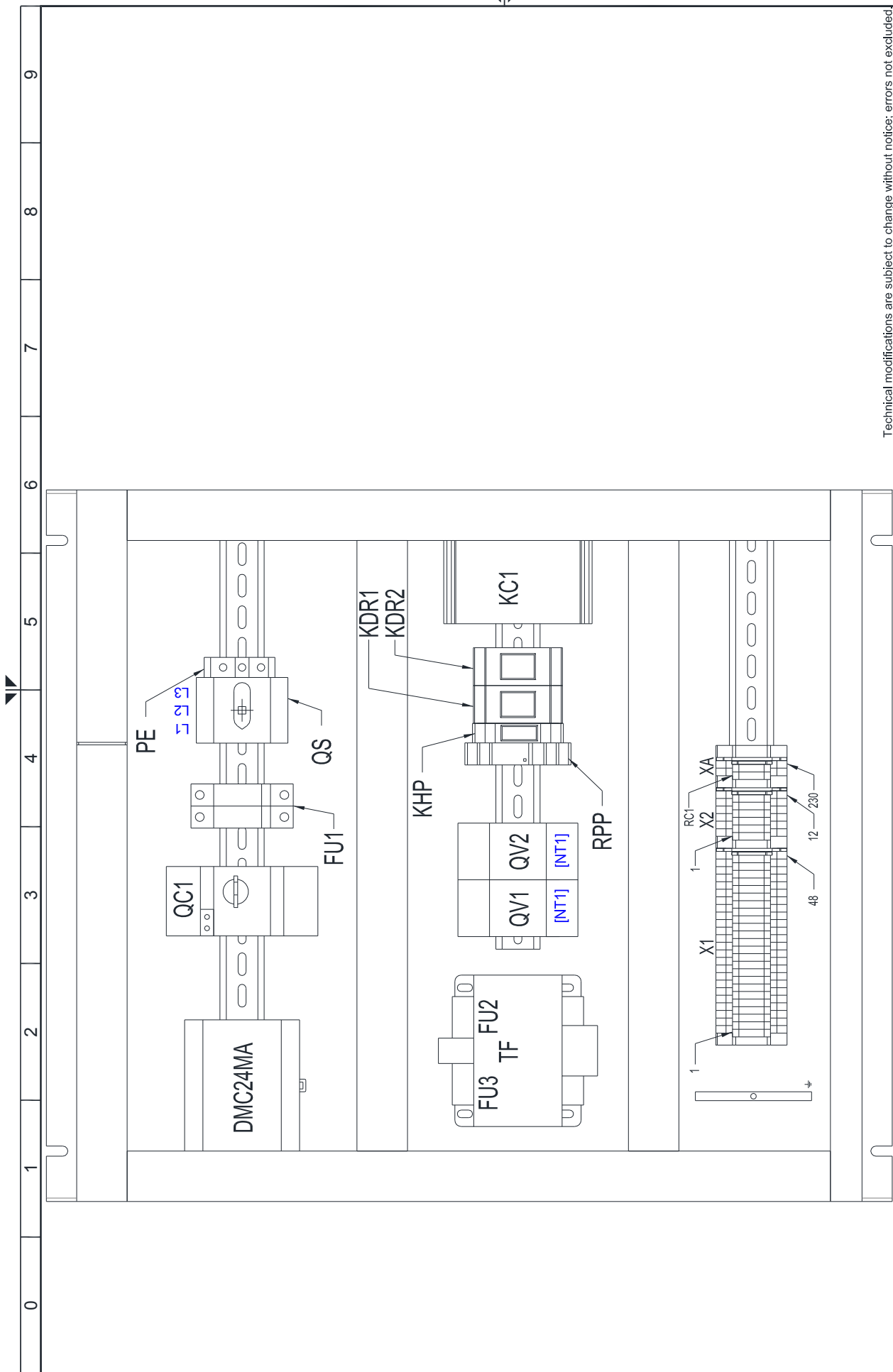

Technical modifications are subject to change without notice; errors not excluded.

Drawing no.: BKRA5478QCD021
 Rev.: 00
 Note: -
 Sheet 08 of 08

BEKO TECHNOLOGIES GMBH
<http://www.beko-technologies.com>





EU-Konformitätserklärung

Wir erklären hiermit, dass die nachfolgend bezeichneten Produkte den Anforderungen der einschlägigen Richtlinien und technischen Normen entsprechen. Diese Erklärung bezieht sich nur auf die Produkte in dem Zustand, in dem sie von uns in Verkehr gebracht wurden. Nicht vom Hersteller angebrachte Teile und/oder nachträglich vorgenommene Eingriffe bleiben unberücksichtigt.

Produktbezeichnung: DRYPOINT® RA
Modelle: 750, 870, 960, 1080, 1300, 1490, 1800, 2200, 2400, 3000, 3600, 4400, 5400, 6600, 7200, 8800, 10800, 13200
Spannungsvarianten: ≥ 110 VAC
Max. Betriebsdruck: 14 bar (g)
Produktbeschreibung und Funktion: Kältetrockner zur Herabsetzung des Drucktaupunkts in Druckluft

Maschinen-Richtlinie 2006/42/EG

Angewandte harmonisierte Normen: EN 14119, EN 14120, EN 12100, EN 13849-1; EN 60204-1
Name des Dokumentationsbevollmächtigten: Jürgen Hütter Im Taubental 7 41468 Neuss, Deutschland

Druckgeräte-Richtlinie 2014/68/EU

Angewandte harmonisierte Normen: ASME VIII Div. 1, EN 378-2, EN 10028-3, EN 12451
Angewandtes Konformitätsbewertungsverfahren: Modul A2
Benannte Stelle: British Engineering Services, Manchester, UK

Niederspannungs-Richtlinie 2014/35/EU

Angewandte harmonisierte Normen: EN 60204-1

EMV-Richtlinie 2014/30/EU

Angewandte harmonisierte Normen: EN 61000-6-2:2016, EN 61000-6-4:2018

ROHS II-Richtlinie 2011/65/EU

Die Vorschriften der Richtlinie 2011/65/EU zur Beschränkung der Verwendung bestimmter gefährlicher Stoffe in Elektro- und Elektronikgeräten werden erfüllt.

Die Produkte sind mit dem abgebildeten Zeichen gekennzeichnet:



Der Hersteller trägt die alleinige Verantwortung für die Ausstellung dieser Konformitätserklärung.

Unterzeichnet für und im Namen von:

Neuss, 11.06.2018

BEKO TECHNOLOGIES GMBH

i.V. Christian Riedel
Leiter Qualitätsmanagement International

<p>Headquarter :</p> <p>Deutschland / Germany BEKO TECHNOLOGIES GMBH Im Taubental 7 D-41468 Neuss Tel. +49 2131 988 0 info@beko-technologies.de</p>	<p>中华人民共和国 / China BEKO TECHNOLOGIES (Shanghai) Co. Ltd. Rm. 606 Tomson Commercial Building 710 Dongfang Rd. Pudong Shanghai China P.C. 200122 Tel. +86 21 508 158 85 info@beko-technologies.cn</p>	<p>France BEKO TECHNOLOGIES S.a.r.l. Zone Industrielle 1 rue des Frères Rémy F- 57200 Sarreguemines Tel. +33 387 283 800 Info@beko-technologies.fr</p>
<p>India BEKO COMPRESSED AIR TECHNOLOGIES Pvt. Ltd. Plot No.43/1, CIEEP, Gandhi Nagar, Balanagar, Hyderabad 500 037, INDIA Tel. +91 40 23080275 eric.purushotham@bekoindia.com</p>	<p>Italia / Italy BEKO TECHNOLOGIES S.r.l Via Peano 86/88 I - 10040 Leini (TO) Tel. +39 011 4500 576 info.it@beko-technologies.com</p>	<p>日本 / Japan BEKO TECHNOLOGIES K.K KEIHIN THINK 8 Floor 1-1 Minamiwatarida-machi Kawasaki-ku, Kawasaki-shi JP-210-0855 Tel. +81 44 328 76 01 info@beko-technologies.jp</p>
<p>Benelux BEKO TECHNOLOGIES B.V. Veenen 12 NL - 4703 RB Roosendaal Tel. +31 165 320 300 benelux@beko-technologies.com</p>	<p>Polska / Poland BEKO TECHNOLOGIES Sp. z o.o. ul. Chłapowskiego 47 PL-02-787 Warszawa Tel. +48 22 855 30 95 info.pl@beko-technologies.pl</p>	<p>Scandinavia www.beko-technologies.de</p>
<p>España / Spain BEKO Tecnológica España S.L. Torruella i Urpina 37-42, nave 6 E-08758 Cervelló Tel. +34 93 632 76 68 info.es@beko-technologies.es</p>	<p>South East Asia BEKO TECHNOLOGIES S.E.Asia (Thailand) Ltd. 75/323 Romkiao Road Sansab, Minburi Bangkok 10510 - Thailand Tel. +66 2-918-2477 info.th@beko-technologies.com</p>	<p>臺灣 / Taiwan BEKO TECHNOLOGIES Co.,Ltd 16F-5, No.79, Sec. 1, Xintai 5th Rd., Xizhi Dist., New Taipei City 221, Taiwan (R.O.C.) Tel. +886 2 8698 3998 info@beko.com.tw</p>
<p>Česká Republika / Czech Republic BEKO TECHNOLOGIES s.r.o. Mlýnská 1392 CZ - 562 01 Usti nad Orlici Tel. +420 465 52 12 51 info.cz@beko-technologies.cz</p>	<p>United Kingdom BEKO TECHNOLOGIES LTD. 2 West Court Buntsford Park Road Bromsgrove GB-Worcestershire B60 3DX Tel. +44 1527 575 778 info@beko-technologies.co.uk</p>	<p>USA BEKO TECHNOLOGIES CORP. 900 Great SW Parkway US - Atlanta, GA 30336 Tel. +1 404 924-6900 beko@bekousa.com</p>

Original operating instructions in English.

Subject to technical changes / errors excepted.

DRYPOINT_RA_10800-13200_manual_en_2019_10.doc