

Modbus Installation and operating instructure intelligent paperless recorder **BDL Compact**



■ Table of contents

1. Safety instructions.....	3
2. Instructions	4
2.1 Definition and abbreviation.....	4
2.2 References.....	4
3. Technical data BDL Compact.....	5
3.1 BDL Compact MODBUS RTU specification	5
3.2 BDL Compact MODBUS/ TCP Specification	5
3.3 General Modbus Information	5
3.3.1 Serial transmission modes (RTU).....	6
3.3.2 Ethernet transmission modes	6
4. Installation	7
4.1 RS485 bus wiring (Modbus RTU) – Connection diagram connector „E“	7
4.2 Ethernet connection for Modbus/TCP	8
5. Modbus RTU communication settings.....	8
5.1 Accessing and changing Modbus settings	8
6. Modbus TCP communication settings	10
7. Modbus addressing model.....	10
7.1 Function Code 3 (Read holding register)	11
7.2 Function code 16 (Write multiple registers).....	11
8. Modbus holding register	12
8.1 Basic Values Register	12
8.2 Register Channel Values	13
8.3 Values register	14
8.4 Status Register	17
8.4.1 Register Values Channel 1 ... 4.....	17
8.4.2 Status register Values 5 ... 8.....	18
8.5 Channel description	20
8.6 Alarm Settings.....	23
8.7 Value extended	24
8.8 Data format test.....	26
8.9 Data Bit description	26
8.10 User Units.....	28
9. Appendix	31
9.1 APPENDIX A - Exception codes	31

1. Safety instructions

Please check whether this manual corresponds with the device type.



Please attend to all notes indicated in this instruction manual. It contains essential information which has to be followed during installation, operation and maintenance. Therefore this instruction manual has to be read categorically by the technician as well as by the responsible user/qualified personnel before installation, initiation and maintenance.

This instruction manual has to be available at any time at the operation site of the BDL Compact Regional and national regulations respectively, have to be observed in addition to this instruction manual if necessary.

In case of any obscurities or questions with regard to this manual or the instrument please contact manufacturer.

Warning



Supply voltage!

Contact with supply voltage carrying non-insulated parts may cause an electric shock with injury and death.

Measures:

- Note all applicable regulations for electrical installations (e. g. VDE 0100)!
- Carry out maintenance only in strainless state!
- All electric works are only allowed to be carried out by authorized qualified personnel

Warning



Inadmissible operating parameters!

Undercutting and exceeding respectively of limit values may cause danger to persons and material and may lead to functional and operational disturbances.

Measures:

- Make sure that the BDL Compact is only operated within the admissible limit values indicated on the type label.
- Strict observance of the performance data of the BDL Compact in connection with the application.
- Do not exceed the admissible storage and transportation temperature.

Further safety instructions:

- Attention should also be paid to the applicable national regulations and safety instructions during installation and operation.
- The BDL Compact is not allowed to be used in explosive areas.

Additional remarks:

- Do not overheat the instrument!

Warning



Malfunctions at the BDL Compact!

Faulty installation and insufficient maintenance may lead to malfunctions of the BDL Compact which may affect the measuring results and which may lead to misinterpretations.

2. Instructions

This manual is intended to provide instructions for the installation and use of the BDL Compact MODBUS function. The BDL Compact MODBUS function can let the MODBUS client device to read out the online measurement values. This manual is not intended to be a complete tutorial on the MODBUS RTU protocol, and it is assumed the end user already has a general working knowledge of MODBUS RTU Communications, especially in respect of client station configuration and operation. However an overview is included in the following section to explain some of the fundamental aspects of the protocol.

2.1 Definition and abbreviation

CRC	Cyclic Redundancy Check Used for error—checking in MODBUS RTU. See appendix
Modbus client	A MODBUS device, which is able to access data in one or more connected MODBUS servers
Modbus server	A MODBUS device, which is able to respond to requests from a single MODBUS client
Modbus Address	Throughout this document the following notation is used to address MODBUS RTU registers see chapter 8 Addressing: Holding Register 1009 is addressed in messages by 1008
PDU	MODBUS protocol data unit
ADU	MODBUS application data unit
MBAP	MODBUS application protocol
RS485	Refers to the 2—wire communication standard defined by EIA/TIA-485. (Physical layer)
Ethernet	

2.2 References

1. MODBUS over Serial Line Specification and Implementation Guide V1.02 modbus.org 2006 Dec 20
2. MODBUS APPLICATION PROTOCOL SPECIFICATION V1.1b modbus.org 2006 Dec 28
3. MODBUS Messaging on TCP/IP implementation Guide V1.0b 2006 Oct 34
4. BDL Compact operation manual

3. Technical data BDL Compact

3.1 BDL Compact MODBUS RTU specification

Device type	Server
Baud Rates	1200, 2400, 4800, 9600, 19200, 38400 bps
Device address range	1 ... 247
Electrical Interface	RS485, 2 wire (Internal Connector X4.1)
Protocol	RTU
Supported function code	3 read holding register 16 write multiple register
Broadcast	No
Standard	Modbus over serial line V1.02

3.2 BDL Compact MODBUS/ TCP Specification

Device type	Server
Device address range	1 ... 247
Electrical Interface	Ethernet, RJ45
Protocol	MODBUS/TCP
IP address	Obtained from DHCP or static
Port	502
Supported function code	3 read holding register 16 write multiple register
Standard	Modbus Messaging on TCP/IP Implementation Guide V1.0b

3.3 General Modbus Information

The BDL Compact Modbus module complies with the Modbus serial line protocol [Reference 1]. Among other things this implies a **client-server** protocol at level 2 of the OSI model. One node (the client) issues explicit commands to one of the „server“-nodes and processes responses. server nodes will not transmit data without a request from the client node, and do not communicate with other servers. Modbus is a mono **client system**, which means that only one **client** can be connected at the time.

3.3.1 Serial transmission modes (RTU)

The BDL Compact Modbus mode support only one serial transmission modes; the RTU mode. The transmission mode defines the bit contents of message fields transmitted serially on the line. It determines how information is packed into the message fields and decoded. The transmission mode and serial port parameters must be the same for all devices on a Modbus serial line.

RTU mode Modbus Application Data Unit (ADU) frame is shown below, and is valid for both requests and responses.

Client Address	Function code	Data	CRC
1 byte	1 byte	0 ... 252 byte(s)	2 bytes

Table 1

Further details of the Modbus protocol can be found in Reference 1 and 2.

3.3.2 Ethernet transmission modes

The BDL Compact Modbus mode supports the **Modbus/TCP only**

The transmission mode defines the bit contents of message fields transmitted serially on the line. It determines how information is packed into the message fields and decoded.

The transmission mode and serial port parameters must be the same for all devices on a Modbus serial line.

Modbus/TCP mode Modbus Application Data Unit (ADU) frame is shown below, and is valid for both requests and responses

Modbus/TCP MBAP Header			PDU		
Transaction Id	Protocol Id	Length	Unit Id	Function Code	Data
2 byte	2 byte	2 byte	1 byte	1 byte	0 ... 252 byte (s)

Table 2

4. Installation

4.1 RS485 bus wiring (Modbus RTU) – Connection diagram connector „E“

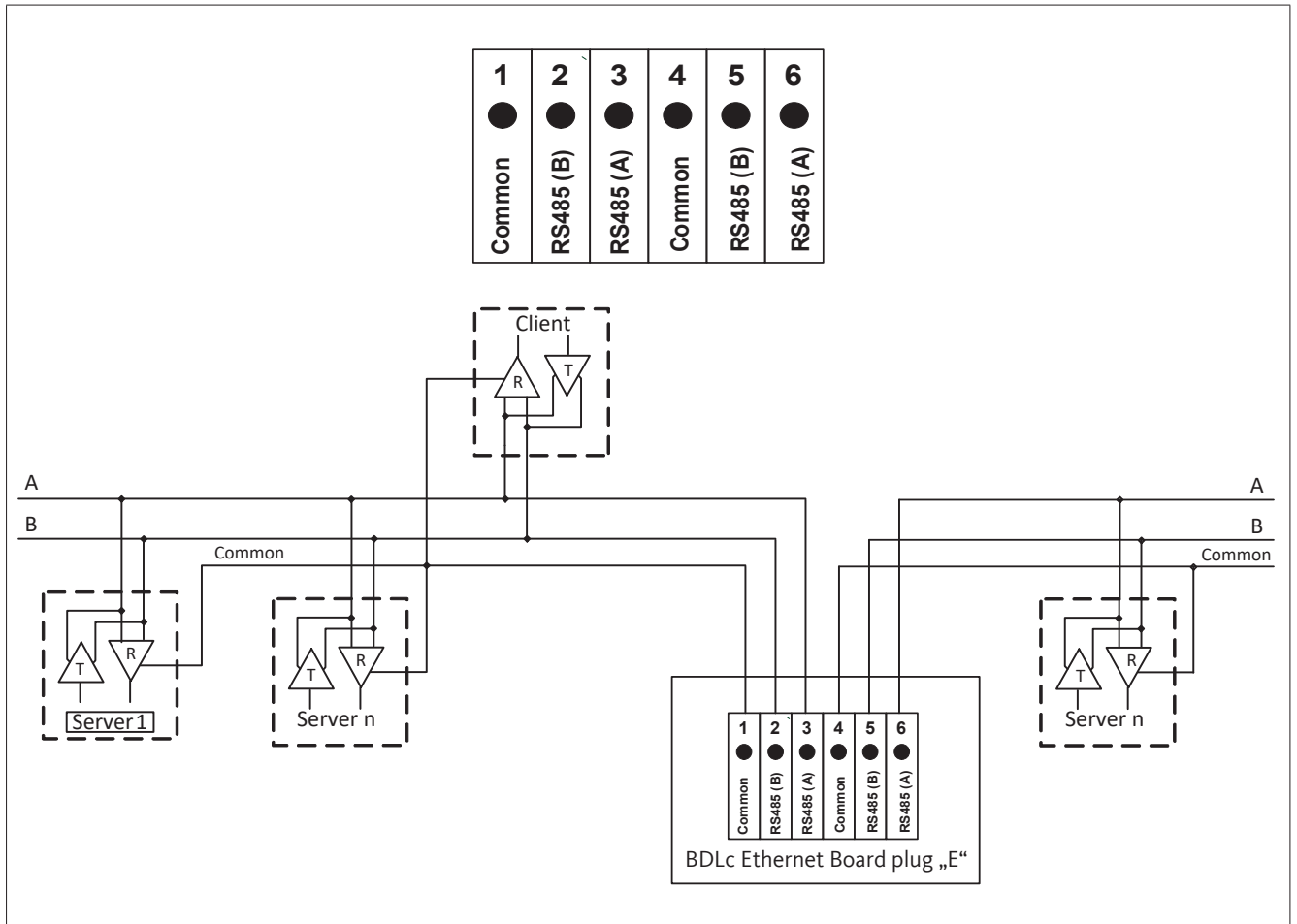

Bus cable:

Only cables according to the recommendations of EIA 485 standard should be used. A maximum of 64 devices may be connected to one segment. The bus cable must be laid at a distance of at least 20 cm from other cables. It should be laid in a separate, conductive, and earthed cable trunking. It must be ensured that no potential differences occur between the individual devices on the bus.

Cable specification:

Impedance:	135 -165 Ohm @ 3 to 20 Mhz
Cable capacity:	< 30 pF/m
Cable diameter:	> 0.64 mm
Cross section:	> 0.34 mm ² , conforms to AWG 22
Loop resistance	< 110 Ohm per km
Screening:	Cu shielding braid or shielding braid and shielding foil

4.2 Ethernet connection for Modbus/TCP

For easy Ethernet cable connection to your network an ordinary RJ45 Ethernet cable connection is provided.

Cable:

An Ethernet cable with category 5 or better is to be used.

5. Modbus RTU communication settings

Before communication with the client, baudrate, address, and framing must be defined

5.1 Accessing and changing Modbus settings

First step:

Main menu → Settings → Device settings → Modbus settings

The settings are all protected by a password!

Inputs and changes have to be confirmed by pressing OK in general!

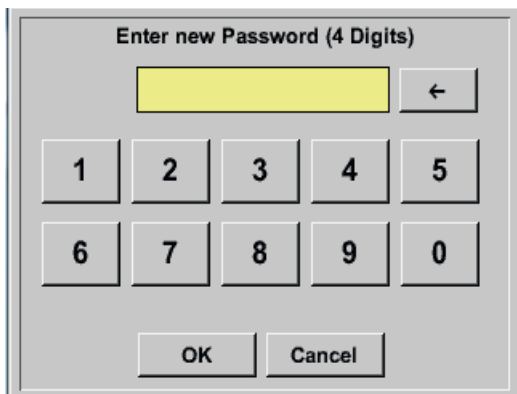
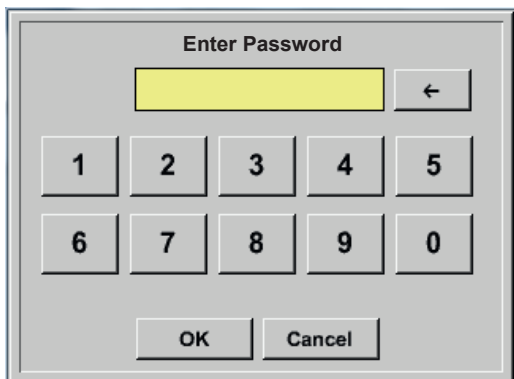

Factory settings for password at the time of delivery: 0000 (4 times zero).
If required, the password can be changed in the [Password settings](#).
The new password must be entered two times in a row and in each case confirmed with **OK**.

If an incorrect password is entered there appears [Enter password](#) or [New password repeat](#) in red font.
If you can't remember the password, please use Master password in order to enter a new password.
Remark:
The Master password is supplied together with the instrument's documentation.

Main menu → Settings → Device settings → Modbus settings

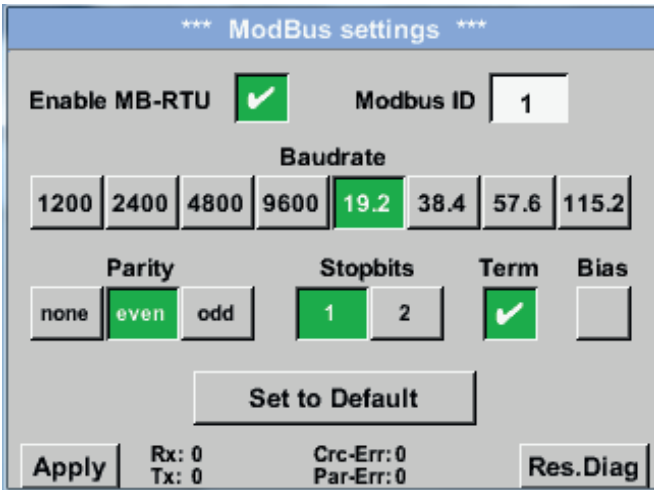

Here please define your communication parameters. **Modbus Id, Baudrate, Stopbits, Parity, Term and Bias** Enable the RTU Modbus by activation of the **enable Modbus** button.

Confirm the changes by pressing the button **Apply** **Remark:** Only in case of changes the button **Apply** appears else to go back with button **Back**

By pressing the button **Set to Default** the default values will be defined.

Default values:

Baudrate:	19200 bps
Parity:	even
Stopbits	1

In case the BDL Compact is at the bus end (last server in the bus) then the Modbus have to be terminated. This is done for the BDL Compact by SW by activation of the **Term** and **Bias** Button

Note:

It is recommended **NOT** to use the default address in a multi-server network. It is of great importance to ensure at the time of the procedure of device addressing, that there is not two devices with the same address. In such a case, an abnormal behavior of the whole serial bus can occur, the client being then in the impossibility to communicate with all presents on the bus.

6. Modbus TCP communication settings

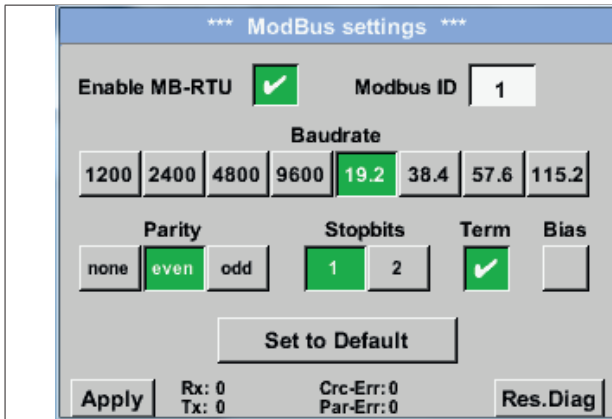

By communication via Modbus TCP the **Modbus Id** have to be set only and confirmed by pressing **Apply** button

7. Modbus addressing model

The BDL Compact RS485 Modbus allows read/write access according chapter 8
 Not defined registers are not accessible / not supported.

Byte Order:

The size of each Modbus-register is 2 Byte. For a 32 bit value two Modbusregister will be read out by the BDL Compact. Accordingly for a 16bit Value only one register is read.

Out formats of BDL Compact:

Single word			Double word				
	HByte	LByte		HWord	LWord		
	HByte	LByte		HByte	LByte	HByte	LByte
18 =>	00	12	29235175522=>	AE	41	56	52
Data Order	1. Byte	2. Byte	Data Order	1.Byte	2.Byte	3.Byte	4.Byte
	12	00		56	52	AE	41

For verification of a correct dataformat please read out register 64000 or 64002.

Result should be.

Register 64000: Long Integer Value =1000000

Register 64002: Float Value = 1000000.0

7.1 Function Code 3 (Read holding register)

General exceptions:

- Requesting less than 1 or more than 125 registers => Exception 3 (Illegal data value)
- Requesting more than max. message size (27 registers) => Exception 2 (Illegal data address)
- Requesting data out of defined range of registers chapter 8 => Exception 2 (Illegal data address)

Application exceptions:

- Application errors => Exception 4 (server device error)

Holes/register alignment:

- The read command always returns data if no exception is given. Bad Start/end alignment will result in only parts of the data item being read.

7.2 Function code 16 (Write multiple registers)

In general only status register (register 2001 – 2064) are writable.

General exceptions:

- Writing less than 1 or more than 63 registers => Exception 3 (Illegal data value)
- If ByteCount is not exactly 2 times NoOfRegisters => Exception 3 (Illegal data value)
- Exceeding max. message size (27 registers) => Exception 2 (Illegal data address)
- Writing data out of defined register range chapter 8 => Exception 2 (Illegal data address)

Application exceptions:

- Application errors => Exception 4 (server device error)
- Application errors include writing to ReadOnly holding registers

Holes / register alignment:

- If start-address is not the start of a mapped holding register => Exception 2 (Illegal data address)
- Writing to holes is allowed (ie ignored - and no exception occurs) — except for the condition described above

8. Modbus holding register

8.1 Basic Values Register

Modbus Register	Modbus Address	No.of Byte	Data Type	Description	Default Setting	Read Write	Comment
1	0	4	Dword	Serial Number	0	R	
3	2	8	String	HostName	0	R	
7	6	4	Dword	HardwareVersion	0	R	<code>sprintf(str,"%u.%02u", hw>>16,hw&0xffff);</code>
9	8	4	Dword	Softwareversion	0	R	<code>sprintf(str,"%u.%02u", sw>>16,sw&0xffff);</code>
11	10	8	Byte(6)	MAC Adress	0	R	Upper 2 bytes are zero
15	14	4	Dword	Calibration Date	0	R	Unix Time
17	16	4	Dword	Runtime Counter	0	R	Value in seconds
19	18	4	Dword	Timet	0	R	Unix Time
21	20	16	String	Brand Name	0	R	
29	28	2	Word	Modbus ID	0	R	Modbus ID
30	29	2	Word	free	0	R	free
31	30	4	Dword	MbRTU Rx Packets OK	0	R	valid RTU telegrams received
33	32	4	Dword	MbRTU Tx Packets	0	R	RTU telegrams transmitted
35	34	4	Dword	MbRTU CRC Errors	0	R	CRC Errors
37	36	4	Dword	MbRtu Parity Errors	0	R	Parity Errors





8.2 Register Channel Values

Important:

When reading SF xx sensors, the following points must be observed:

- The register assignment for SF xx sensors values differs from the register assignment of other sensors and parameters.
- Consumption value(s) for SF xx sensors are always integer values I4(32b), contrary to the table.

Arrangement SF xxStandard (w/o pressure)

Aufzeichnen			
1st value	<input checked="" type="checkbox"/>	 Flow	10.31 m³/h
3rd value	<input type="checkbox"/>	 Consumpt.	3499 m³
5th value	<input type="checkbox"/>	 Temp.	17.91 °C
8th value	<input type="checkbox"/>	 Velocity	1.59 m/s

Example for channel 1:

Channel	Value	Register
Value A1	1	→ Register 1000 (Flow)
Value A1	3	→ Register 1004 (Consumption)
Value A1	5	→ Register 1200 (Temperature)
Value A1	8	→ Register 1206 (Velocity)

8.3 Values register

Modbus Register	Modbus Address	No.of Byte	Data Type	Description	Default Setting	Read Write	Comment
1001	1000	4	Float/ Dword	Channel A1 1st value	0	R	BDL Compact Data Value *1)
1003	1002	4	Float/ Dword	Channel A1 2nd value	0	R	BDL Compact Data Value *1)
1005	1004	4	Float/ Dword	Channel A1 3rd value	0	R	BDL Compact Data Value *1)
1007	1006	4	Float/ Dword	Channel A1 4th value	0	R	BDL Compact Data Value *1)
1009	1008	4	Float/ Dword	Channel A2 1st value	0	R	BDL Compact Data Value *1)
1011	1010	4	Float/ Dword	Channel A2 2nd value	0	R	BDL Compact Data Value *1)
1013	1012	4	Float/ Dword	Channel A2 3rd value	0	R	BDL Compact Data Value *1)
1015	1014	4	Float/ Dword	Channel A2 4th value	0	R	BDL Compact Data Value *1)
1017	1016	4	Float/ Dword	Channel B1 1st value	0	R	BDL Compact Data Value *1)
1019	1018	4	Float/ Dword	Channel B1 2nd value	0	R	BDL Compact Data Value *1)
1021	1020	4	Float/ Dword	Channel B1 3rd value	0	R	BDL Compact Data Value *1)
1023	1022	4	Float/ Dword	Channel B1 4th value	0	R	BDL Compact Data Value *1)
1025	1024	4	Float/ Dword	Channel B2 1st value	0	R	BDL Compact Data Value *1)
1027	1026	4	Float/ Dword	Channel B2 2nd value	0	R	BDL Compact Data Value *1)
1029	1028	4	Float/ Dword	Channel B2 3rd value	0	R	BDL Compact Data Value *1)
1031	1030	4	Float/ Dword	Channel B2 4th value	0	R	BDL Compact Data Value *1)
1033	1032	4	Float/ Dword	Channel V1 1st value	0	R	BDL Compact Data Value *1)
1035	1034	4	Float/ Dword	Channel V1 2nd value	0	R	BDL Compact Data Value *1)
1037	1036	4	Float/ Dword	Channel V1 3rd value	0	R	BDL Compact Data Value *1)
1039	1038	4	Float/ Dword	Channel V1 4th value	0	R	BDL Compact Data Value *1)
1041	1040	4	Float/ Dword	Channel V2 1st value	0	R	BDL Compact Data Value *1)
1043	1042	4	Float/ Dword	Channel V2 2nd value	0	R	BDL Compact Data Value *1)

Modbus Register	Modbus Address	No.of Byte	Data Type	Description	Default Setting	Read Write	Comment
1045	1044	4	Float/ Dword	Channel V2 3rd value	0	R	BDL Compact Data Value *1)
1047	1046	4	Float/ Dword	Channel V2 4th value	0	R	BDL Compact Data Value *1)
1049	1048	4	Float/ Dword	Channel V3 1st value	0	R	BDL Compact Data Value *1)
1051	1050	4	Float/ Dword	Channel V3 2nd value	0	R	BDL Compact Data Value *1)
1053	1052	4	Float/ Dword	Channel V3 3rd value	0	R	BDL Compact Data Value *1)
1055	1054	4	Float/ Dword	Channel V3 4th value	0	R	BDL Compact Data Value *1)
1057	1056	4	Float/ Dword	Channel V4 1st value	0	R	BDL Compact Data Value *1)
1059	1058	4	Float/ Dword	Channel V4 2nd value	0	R	BDL Compact Data Value *1)
1061	1060	4	Float/ Dword	Channel V4 3rd value	0	R	BDL Compact Data Value *1)
1063	1062	4	Float/ Dword	Channel V4 4th value	0	R	BDL Compact Data Value *1)
1201	1200	4	Float/ Dword	Channel A1 5th value	0	R	BDL Compact Data Value *1)
1203	1202	4	Float/ Dword	Channel A1 6th value	0	R	BDL Compact Data Value *1)
1205	1204	4	Float/ Dword	Channel A1 7th value	0	R	BDL Compact Data Value *1)
1207	1206	4	Float/ Dword	Channel A1 8th value	0	R	BDL Compact Data Value *1)
1209	1208	4	Float/ Dword	Channel A2 5th value	0	R	BDL Compact Data Value *1)
1211	1210	4	Float/ Dword	Channel A2 6th value	0	R	BDL Compact Data Value *1)
1213	1212	4	Float/ Dword	Channel A2 7th value	0	R	BDL Compact Data Value *1)
1215	1214	4	Float/ Dword	Channel A2 8th value	0	R	BDL Compact Data Value *1)
1217	1216	4	Float/ Dword	Channel B1 5th value	0	R	BDL Compact Data Value *1)
1219	1218	4	Float/ Dword	Channel B1 6th value	0	R	BDL Compact Data Value *1)
1221	1220	4	Float/ Dword	Channel B1 7th value	0	R	BDL Compact Data Value *1)
1223	1222	4	Float/ Dword	Channel B1 8th value	0	R	BDL Compact Data Value *1)
1225	1224	4	Float/ Dword	Channel B2 5th value	0	R	BDL Compact Data Value *1)

Modbus Register	Modbus Address	No.of Byte	Data Type	Description	Default Setting	Read Write	Comment
1227	1226	4	Float/ Dword	Channel B2 6th value	0	R	BDL Compact Data Value *1)
1229	1228	4	Float/ Dword	Channel B2 7th value	0	R	BDL Compact Data Value *1)
1231	1230	4	Float/ Dword	Channel B2 8th value	0	R	BDL Compact Data Value *1)
1233	1232	4	Float/ Dword	Channel V1 5th value	0	R	BDL Compact Data Value *1)
1235	1234	4	Float/ Dword	Channel V1 6th value	0	R	BDL Compact Data Value *1)
1237	1236	4	Float/ Dword	Channel V1 7th value	0	R	BDL Compact Data Value *1)
1239	1238	4	Float/ Dword	Channel V1 8th value	0	R	BDL Compact Data Value *1)
1241	1240	4	Float/ Dword	Channel V2 5th value	0	R	BDL Compact Data Value *1)
1243	1242	4	Float/ Dword	Channel V2 6th value	0	R	BDL Compact Data Value *1)
1245	1244	4	Float/ Dword	Channel V2 7th value	0	R	BDL Compact Data Value *1)
1247	1246	4	Float/ Dword	Channel V2 8th value	0	R	BDL Compact Data Value *1)
1249	1248	4	Float/ Dword	Channel V3 5th value	0	R	BDL Compact Data Value *1)
1251	1250	4	Float/ Dword	Channel V3 6th value	0	R	BDL Compact Data Value *1)
1253	1252	4	Float/ Dword	Channel V3 7th value	0	R	BDL Compact Data Value *1)
1255	1254	4	Float/ Dword	Channel V3 8th value	0	R	BDL Compact Data Value *1)
1257	1256	4	Float/ Dword	Channel V4 5th value	0	R	BDL Compact Data Value *1)
1259	1258	4	Float/ Dword	Channel V4 6th value	0	R	BDL Compact Data Value *1)
1261	1260	4	Float/ Dword	Channel V4 7th value	0	R	BDL Compact Data Value *1)
1263	1262	4	Float/ Dword	Channel V4 8th value	0	R	BDL Compact Data Value *1)

8.4 Status Register

8.4.1 Register Values Channel 1 ... 4

Modbus Register	Modbus Address	No.of Byte	Data Type	Description	Default Setting	Read Write	Comment
2001	2000	2	word	Channel A1 Value 1 Status	0	R/W	Status *2)
2002	2001	2	word	Channel A1 Value 2 Status	0	R/W	Status *2)
2003	2002	2	word	Channel A1 Value 3 Status	0	R/W	Status *2)
2004	2003	2	word	Channel A1 Value 4 Status	0	R/W	Status *2)
2005	2004	2	word	Channel A2 Value 1 Status	0	R	Status *2)
2006	2005	2	word	Channel A2 Value 2 Status	0	R	Status *2)
2007	2006	2	word	Channel A2 Value 3 Status	0	R	Status *2)
2008	2007	2	word	Channel A2 Value 4 Status	0	R	Status *2)
2009	2008	2	word	Channel B1 Value 1 Status	0	R	Status *2)
2010	2009	2	word	Channel B1 Value 2 Status	0	R	Status *2)
2011	2010	2	word	Channel B1 Value 3 Status	0	R	Status *2)
2012	2011	2	word	Channel B1 Value 4 Status	0	R	Status *2)
2013	2012	2	word	Channel B2 Value 1 Status	0	R	Status *2)
2014	2013	2	word	Channel B2 Value 2 Status	0	R	Status *2)
2015	2014	2	word	Channel B2 Value 3 Status	0	R	Status *2)
2016	2015	2	word	Channel B2 Value 4 Status	0	R	Status *2)
2017	2016	2	word	Channel V1 Value 1 Status	0	R	Status *2)
2018	2017	2	word	Channel V1 Value 2 Status	0	R	Status *2)
2019	2018	2	word	Channel V1 Value 3 Status	0	R	Status *2)
2020	2019	2	word	Channel V1 Value 4 Status	0	R	Status *2)

Modbus Register	Modbus Address	No.of Byte	Data Type	Description	Default Setting	Read Write	Comment
2021	2020	2	word	Channel V2 Value 5 Status	0	R	Status *2)
2022	2021	2	word	Channel V2 Value 6 Status	0	R	Status *2)
2023	2022	2	word	Channel V2 Value 7 Status	0	R	Status *2)
2024	2023	2	word	Channel V2 Value 8 Status	0	R	Status *2)
2025	2024	2	word	Channel V3 Value 5 Status	0	R	Status *2)
2026	2025	2	word	Channel V3 Value 6 Status	0	R	Status *2)
2027	2026	2	word	Channel V3 Value 7 Status	0	R	Status *2)
2028	2027	2	word	Channel V3 Value 8 Status	0	R	Status *2)
2029	2028	2	word	Channel V4 Value 5 Status	0	R	Status *2)
2030	2029	2	word	Channel V4 Value 6 Status	0	R	Status *2)
2031	2030	2	word	Channel V4 Value 7 Status	0	R	Status *2)
2032	2031	2	word	Channel V4 Value 8 Status	0	R	Status *2)

8.4.2 Status register Values 5 ... 8

Modbus Register	Modbus Address	No.of Byte	Data Type	Description	Default Setting	Read Write	Comment
2101	2100	2	word	Channel A1 Value 5 Status	0	R	Status *2)
2102	2101	2	word	Channel A1 Value 6 Status	0	R	Status *2)
2103	2102	2	word	Channel A1 Value 7 Status	0	R	Status *2)
2104	2103	2	word	Channel A1 Value 8 Status	0	R	Status *2)
2105	2104	2	word	Channel A2 Value 5 Status	0	R	Status *2)
2106	2105	2	word	Channel A2 Value 6 Status	0	R	Status *2)

Modbus Register	Modbus Address	No.of Byte	Data Type	Description	Default Setting	Read Write	Comment
2107	2106	2	word	Channel A2 Value 7 Status	0	R	Status *2)
2108	2107	2	word	Channel A2 Value 8 Status	0	R	Status *2)
2109	2108	2	word	Channel B1 Value 5 Status	0	R	Status *2)
2110	2109	2	word	Channel B1 Value 6 Status	0	R	Status *2)
2111	2110	2	word	Channel B1 Value 7 Status	0	R	Status *2)
2112	2111	2	word	Channel B1 Value 8 Status	0	R	Status *2)
2113	2112	2	word	Channel B2 Value 5 Status	0	R	Status *2)
2114	2113	2	word	Channel B2 Value 6 Status	0	R	Status *2)
2115	2114	2	word	Channel B2 Value 7 Status	0	R	Status *2)
2116	2115	2	word	Channel B2 Value 8 Status	0	R	Status *2)
2117	2116	2	word	Channel V1 Value 5 Status	0	R	Status *2)
2118	2117	2	word	Channel V1 Value 6 Status	0	R	Status *2)
2119	2118	2	word	Channel V1 Value 7 Status	0	R	Status *2)
2120	2119	2	word	Channel V1 Value 8 Status	0	R	Status *2)
2121	2120	2	word	Channel A1 Value 1 Status	0	R/W	Status *2)
2122	2121	2	word	Channel A1 Value 2 Status	0	R/W	Status *2)
2123	2122	2	word	Channel A1 Value 3 Status	0	R/W	Status *2)
2124	2123	2	word	Channel A1 Value 4 Status	0	R	Status *2)
2125	2124	2	word	Channel A2 Value 1 Status	0	R	Status *2)
2126	2125	2	word	Channel A2 Value 2 Status	0	R	Status *2)
2127	2126	2	word	Channel A2 Value 3 Status	0	R	Status *2)

Modbus Register	Modbus Address	No.of Byte	Data Type	Description	Default Setting	Read Write	Comment
2128	2127	2	word	Channel A2 Value 4 Status	0	R	Status *2)
2129	2128	2	word	Channel A3 Value 1 Status	0	R	Status *2)
2130	2129	2	word	Channel A3 Value 2 Status	0	R	Status *2)
2131	2130	2	word	Channel A3 Value 3 Status	0	R	Status *2)
2132	2131	2	word	Channel A3 Value 4 Status	0	R	Status *2)

8.5 Channel description

Modbus Register	Modbus Address	No.of Byte	Data Type	Description	Default Setting	Read Write	Comment
3001	3000	2	word	Channel A1 sensor type	0	R	Sensor Type *3)
3002	3001	24	string	Channel Name	0	R	Sensor Name *4)
3014	3013	2	word	name/unit index value 1	0	R	Value description *5)
3015	3014	2	word	name/unit index value 2	0	R	Value description *5)
3016	3015	2	word	name/unit index value 3	0	R	Value description *5)
3017	3016	2	word	name/unit index value 4	0	R	Value description *5)
3018	3017	2	word	name/unit index value 5	0	R	Value description *5)
3019	3018	2	word	name/unit index value 6	0	R	Value description *5)
3020	3019	2	word	name/unit index value 7	0	R	Value description *5)
3021	3020	2	word	name/unit index value 8	0	R	Value description *5)
3033	3032	2	word	Channel A2 sensor type	0	R	Sensor Type *3)
3034	3033	24	string	Channel Name	0	R	Sensor Name *4)
3046	3045	2	word	name/unit index value 1	0	R	Value description *5)
3047	3046	2	word	name/unit index value 2	0	R	Value description *5)
3048	3047	2	word	name/unit index value 3	0	R	Value description *5)

Modbus Register	Modbus Address	No.of Byte	Data Type	Description	Default Setting	Read Write	Comment
3049	3048	2	word	name/unit index value 4	0	R	Value description *5)
3050	3049	2	word	name/unit index value 5	0	R	Value description *5)
3051	3050	2	word	name/unit index value 6	0	R	Value description *5)
3052	3051	2	word	name/unit index value 7	0	R	Value description *5)
3053	3052	2	word	name/unit index value 8	0	R	Value description *5)
3065	3064	2	word	Channel B1 sensor type	0	R	Sensor Type *3)
3066	3065	24	string	Channel Name	0	R	Sensor Name *4)
3078	3077	2	word	name/unit index value 1	0	R	Value description *5)
3079	3078	2	word	name/unit index value 2	0	R	Value description *5)
3080	3079	2	word	name/unit index value 3	0	R	Value description *5)
3081	3080	2	word	name/unit index value 4	0	R	Value description *5)
3082	3081	2	word	name/unit index value 5	0	R	Value description *5)
3083	3082	2	word	name/unit index value 6	0	R	Value description *5)
3084	3083	2	word	name/unit index value 7	0	R	Value description *5)
3085	3084	2	word	name/unit index value 8	0	R	Value description *5)
3097	3096	2	word	Channel B2 sensor type	0	R	Sensor Type *3)
3098	3097	24	string	Channel Name	0	R	Sensor Name *4)
3110	3009	2	word	name/unit index value 1	0	R	Value description *5)
3111	3110	2	word	name/unit index value 2	0	R	Value description *5)
3112	3111	2	word	name/unit index value 3	0	R	Value description *5)
3113	3112	2	word	name/unit index value 4	0	R	Value description *5)
3114	3113	2	word	name/unit index value 5	0	R	Value description *5)
3115	3114	2	word	name/unit index value 6	0	R	Value description *5)
3116	3115	2	word	name/unit index value 7	0	R	Value description *5)

Modbus Register	Modbus Address	No.of Byte	Data Type	Description	Default Setting	Read Write	Comment
3117	3116	2	word	name/unit index value 8	0	R	Value description *5)
3129	3128	2	word	Channel V1 sensor type	0	R	Sensor Type *3)
3130	3129	24	string	Channel Name	0	R	Sensor Name *4)
3142	3141	2	word	name/unit index value 1	0	R	Value description *5)
3143	3142	2	word	name/unit index value 2	0	R	Value description *5)
3149	3143			name/unit index value 3			Value description *5)
3145	3149	2	word	name/unit index value 4	0	R	Value description *5)
3146	3145	2	word	name/unit index value 5	0	R	Value description *5)
3147	3146	2	word	name/unit index value 6	0	R	Value description *5)
3148	3147	2	word	name/unit index value 7	0	R	Value description *5)
3149	3148	2	word	name/unit index value 8	0	R	Value description *5)
3161	3160	2	word	Channel V2 sensor type	0	R	Sensor Type *3)
3162	3161	24	string	Channel Name	0	R	Sensor Name *4)
3174	3173	2	word	name/unit index value 1	0	R	Value description *5)
3175	3174	2	word	name/unit index value 2	0	R	Value description *5)
3176	3175	2	word	name/unit index value 3	0	R	Value description *5)
3177	3176	2	word	name/unit index value 4	0	R	Value description *5)
3178	3177	2	word	name/unit index value 5	0	R	Value description *5)
3179	3178	2	word	name/unit index value 6	0	R	Value description *5)
3180	3179	2	word	name/unit index value 7	0	R	Value description *5)
3181	3180	2	word	name/unit index value 8	0	R	Value description *5)
3193	3292	2	word	Channel V3 sensor type	0	R	Sensor Type *3)
3194	3293	24	string	Channel Name	0	R	Sensor Name *4)
3206	3205	2	word	name/unit index value 1	0	R	Value description *5)

Modbus Register	Modbus Address	No.of Byte	Data Type	Description	Default Setting	Read Write	Comment
3207	3206	2	word	name/unit index value 2	0	R	Value description *5)
3208	3207	2	word	name/unit index value 3	0	R	Value description *5)
3209	3208	2	word	name/unit index value 4	0	R	Value description *5)
3210	3209	2	word	name/unit index value 5	0	R	Value description *5)
3211	3210	2	word	name/unit index value 6	0	R	Value description *5)
3112	3211	2	word	name/unit index value 7	0	R	Value description *5)
3113	3112	2	word	name/unit index value 8	0	R	Value description *5)
3225	3224	2	word	Channel V4 sensor type	0	R	Sensor Type *3)
3226	3225	24	string	Channel Name	0	R	Sensor Name *4)
3238	3237	2	word	name/unit index value 1	0	R	Value description *5)
3239	3238	2	word	name/unit index value 2	0	R	Value description *5)
3240	3239	2	word	name/unit index value 3	0	R	Value description *5)
3241	3240	2	word	name/unit index value 4	0	R	Value description *5)
3242	3241	2	word	name/unit index value 5	0	R	Value description *5)
3243	3242	2	word	name/unit index value 6	0	R	Value description *5)
3244	3243	2	word	name/unit index value 7	0	R	Value description *5)
3245	3244	2	word	name/unit index value 8	0	R	Value description *5)

8.6 Alarm Settings

Modbus Register	Modbus Address	No.of Byte	Data Type	Description	Default Setting	Read Write	Comment
4001	4000	2	word	Channel / Value	0	R	Alarmsettings #1 *6)
4002	4001	2	word	Relais	0	R	relais setting *7)
4003	4002	4	float	upper warning value	0	R	
4005	4004	4	float	Hysteresis for above	0	R	

Modbus Register	Modbus Address	No.of Byte	Data Type	Description	Default Setting	Read Write	Comment
4007	4006	4	float	upper alarm value	0	R	
4009	4008	4	float	Hysteresis for above	0	R	
4011	4010	4	float	lower warning value	0	R	
4013	4012	4	float	Hysteresis for above	0	R	
4015	4014	4	float	lower alarm value	0	R	
4017	4016	4	float	Hysteresis for above	0	R	
4019	4018	4	float	Reserved			
4021	4020	2	word	Channel / Value	0	R	Alarmsettings #1 *6)
4022	4021	2	word	Relais	0	R	relais setting *7)
4023	4022	4	float	upper warning value	0	R	
4025	4024	4	float	Hysteresis for above	0	R	
4027	4026	4	float	upper alarm value	0	R	
4029	4028	4	float	Hysteresis for above	0	R	
4031	4030	4	float	lower warning value	0	R	
4033	4032	4	float	Hysteresis for above	0	R	
4035	4034	4	float	lower alarm value	0	R	
4037	4036	4	float	Hysteresis for above	0	R	
4039	4038	4	float	Reserved			

8.7 Value extended

Modbus Register	Modbus Address	No.of Byte	Data Type	Description	Default Setting	Read Write	Comment
10001	10000	12	string	A1a Value Name long	0	R	string max. 10 character
10007	10006	6	string	A1a Value Name short	0	R	string max. 3 character
10010	10009	2	word	A1a Value Resolution	0	R	0 ... 5

Modbus Register	Modbus Address	No.of Byte	Data Type	Description	Default Setting	Read Write	Comment
10011	10010	30	free	A1a future use	0	R	
10026	10025	12	string	A1b Value Name long	0	R	string max. 10 character
10032	10031	6	string	A1b Value Name short	0	R	string max. 3 character
10035	10034	2	word	A1b Value Resolution	0	R	0 ... 5
10036	10035	30	free	A1b future use	0	R	
10051	10050	12	string	A1c Value Name long	0	R	string max. 10 character
10057	10056	6	string	A1c Value Name short	0	R	string max. 3 character
10060	10059	2	word	A1c Value Resolution	0	R	0 ... 5
10061	10060	30	free	A1c future use	0	R	
10076	10075	12	string	A1d Value Name long	0	R	string max. 10 character
10082	10081	6	string	A1d Value Name short	0	R	string max. 3 character
10085	10084	2	word	A1d Value Resolution	0	R	0 ... 5
10086	10085	30	free	A1d future use	0	R	
10101	10100	12	string	A1e Value Name long	0	R	string max. 10 character
10107	10106	6	string	A1e Value Name short	0	R	string max. 3 character
10110	10109	2	word	A1e Value Resolution	0	R	0 ... 5
10111	10110	30	free	A1e future use	0	R	
10126	10125	12	string	A1f Value Name long	0	R	string max. 10 character
10132	10131	6	string	A1f Value Name short	0	R	string max. 3 character
10135	10134	2	word	A1f Value Resolution	0	R	0..5
10136	10135	30	free	A1f future use	0	R	
10151	10150	12	string	A1g Value Name long	0	R	string max. 10 character
10157	10156	6	string	A1g Value Name short	0	R	string max. 3 character
10160	10159	2	word	A1g Value Resolution	0	R	0 ... 5
10161	10160	30	free	A1g future use	0	R	
10176	10175	12	string	A1h Value Name long	0	R	string max. 10 character

Modbus Register	Modbus Address	No.of Byte	Data Type	Description	Default Setting	Read Write	Comment
10182	10181	6	string	A1h Value Name short	0	R	string max. 3 character
10185	10184	2	word	A1h Value Resolution	0	R	0 ... 5
10186	10185	30	free	A1h future use	0	R	
10201	10200	8*25	xxx	Channel A2	0	R	similar to channel A1
10401	10400	8*25	xxx	Channel A3	0	R	similar to channel A1
10601	10600	8*25	xxx	Channel A4	0	R	similar to channel A1
10801	10800	8*25	xxx	Channel B1	0	R	similar to channel A1
11001	11000	8*25	xxx	Channel B2	0	R	similar to channel A1
11201	11200	8*25	xxx	Channel B3	0	R	similar to channel A1
11401	11400	8*25	xxx	Channel B4	0	R	similar to channel A1
11601	11600	8*25	xxx	Channel C1	0	R	similar to channel A1
11801	11800	8*25	xxx	Channel C2	0	R	similar to channel A1
12001	12000	8*25	xxx	Channel C3	0	R	similar to channel A1
12201	12200	8*25	xxx	Channel C4	0	R	similar to channel A1
12401	12400	8*25	xxx	Channel V1	0	R	similar to channel A1
12601	12600	8*25	xxx	Channel V2	0	R	similar to channel A1
12801	12800	8*25	xxx	Channel V3	0	R	similar to channel A1
13001	13000	8*25	xxx	Channel V4	0	R	similar to channel A1

8.8 Data format test

Modbus Register	Modbus Address	No.of Byte	Data Type	Description	Default Setting	Read Write	Comment
64001	64000	2	Dword	1000000	x	R	format test for Dword
64003	64002	2	float	1000000.0	x	R	format test for float

8.9 Data Bit description

*1)	Data Value	
	Format (Dword / Float) depends on Value Description Bit 15	see below *5)
	Position of Dezimal Point depends on Value Description Bit 14 ... 12	see below *5)

*2)		Data status			
Write 1 to these bits clears Status	Bit	15	Sensor changed	different sensor	
	Bit	14	Sensor setting changed	mayor parameter changed	
	Bit	13	Sensor Alarm settings changed	Alarm settings changed	
	Bit	12	Sensor name changed	minor change	
	Bit	11	Lower Alarm active		
	Bit	10	Lower Warning active		
	Bit	9	Upper Alarm active		
	Bit	8	Upper Warning active		
	Bit	7	tbd	Value status	
	Bit	6	Channel Error	Value status	
	Bit	5	Value Error	Value status	
	Bit	4	out of range	Value status	
	Bit	3	Stopped	Value status	
	Bit	2	UVP status	Value status	
	Bit	1	OCP status	Value status	
	Bit	0	Channel Disconnected	Value status	

*3)		Sensor Type			
	Bit	15 ... 8	Sensor Basic type	0 ... 255	0 = no sensor
	Bit	7 ... 0	Sensor Subtype	0 ... 255	

*4)		Channel Name			
		Name coding in UTF8 (max. 24 Byte)			

*5)		Value description			
	Bit	15	1 = Dword , 0 = float	0,1	
	Bit	14 ... 12	position of dezimal point	0 ... 7	
	Bit	11 ... 7	index of value name	0 ... 31	
	Bit	6 ... 0	index of unit name	0 ... 127	0 = value not used

*6)		Alarm Channel/ Value			
	Bit	11	lower Alarm used		
	Bit	10	lower Warning used		
	Bit	9	upper Alarm used		
	Bit	8	upper Warning used		
	Bit	7	Alarm used (valid)		Alarm settings used
	Bit	6 ... 4	Value Nr	0 ... 7	
	Bit	3 ... 0	Channel	0 ... 11	

*7)	Alarm Relias				
	Bit	15			
	Bit	14			
	Bit	13		Lower alarm Relais 2 used	
	Bit	12		Lower alarm Relais 1 used	
	Bit	11			
	Bit	10			
	Bit	9		Lower warning Relais 2 used	
	Bit	8		Lower warning Relais 1 used	
	Bit	7			
	Bit	6			
	Bit	5		Upper alarm Relais 2 used	
	Bit	4		Upper alarm Relais 1 used	
	Bit	3			
	Bit	2			
	Bit	1		Upper warning Relais 2 used	
	Bit	0		Upper warning Relais 1 used	

8.10 User Units

Modbus Register	Modbus Address	No.of Byte	Data Type	Description	Default Setting	Read Write	Comment
14001	14000	10	string	Unit Name 1	°C	R	UTF8 string (max. 10 character)
14009	14008	10	string	Unit Name 2	°F	R	UTF8 string (max. 10 character)
14017	14016	10	string	Unit Name 3	%RH	R	UTF8 string (max. 10 character)
14025	14024	10	string	Unit Name 4	°Ctd	R	UTF8 string (max. 10 character)
14033	14032	10	string	Unit Name 5	°Ftd	R	UTF8 string (max. 10 character)
14041	14040	10	string	Unit Name 6	mg/kg	R	UTF8 string (max. 10 character)
14049	14048	10	string	Unit Name 7	mg/m ³	R	UTF8 string (max. 10 character)
14057	14056	10	string	Unit Name 8	g/kg	R	UTF8 string (max. 10 character)
14065	14064	10	string	Unit Name 9	g/m ³	R	UTF8 string (max. 10 character)
14073	14072	10	string	Unit Name 10	m/s	R	UTF8 string (max. 10 character)
14081	14080	10	string	Unit Name 11	Ft/min	R	UTF8 string (max. 10 character)

Modbus Register	Modbus Address	No.of Byte	Data Type	Description	Default Setting	Read Write	Comment
14089	14088	10	string	Unit Name 12	Nm/s	R	UTF8 string (max. 10 character)
14097	14096	10	string	Unit Name 13	Nft/min	R	UTF8 string (max. 10 character)
14105	14104	10	string	Unit Name 14	m ³ /h	R	UTF8 string (max. 10 character)
14113	14112	10	string	Unit Name 15	m ³ /min	R	UTF8 string (max. 10 character)
14121	12120	10	string	Unit Name 16	ltr/min	R	UTF8 string (max. 10 character)
14129	14128	10	string	Unit Name 17	ltr/s	R	UTF8 string (max. 10 character)
14137	14136	10	string	Unit Name 18	cfm	R	UTF8 string (max. 10 character)
14145	14144	10	string	Unit Name 19	Nm ³ /h	R	UTF8 string (max. 10 character)
14153	14152	10	string	Unit Name 20	Nm ³ /min	R	UTF8 string (max. 10 character)
14161	14160	10	string	Unit Name 21	NI/min	R	UTF8 string (max. 10 character)
14169	14168	10	string	Unit Name 22	NI/min	R	UTF8 string (max. 10 character)
14177	14176	10	string	Unit Name 23	Ncfm	R	UTF8 string (max. 10 character)
14185	14184	10	string	Unit Name 24	m ³	R	UTF8 string (max. 10 character)
14193	14192	10	string	Unit Name 25	ltr	R	UTF8 string (max. 10 character)
14201	14200	10	string	Unit Name 26	cf	R	UTF8 string (max. 10 character)
14209	14208	10	string	Unit Name 27	Nm ³	R	UTF8 string (max. 10 character)
14217	14216	10	string	Unit Name 28	NItr	R	UTF8 string (max. 10 character)
14225	14224	10	string	Unit Name 29	Ncf	R	UTF8 string (max. 10 character)
14233	14232	10	string	Unit Name 30	ppm	R	UTF8 string (max. 10 character)
14241	14240	10	string	Unit Name 31	atm°C	R	UTF8 string (max. 10 character)
14249	14248	10	string	Unit Name 32	atm°F	R	UTF8 string (max. 10 character)
14257	14256	10	string	Unit Name 33	pa	R	UTF8 string (max. 10 character)
14265	14264	10	string	Unit Name 34	hpa	R	UTF8 string (max. 10 character)

Modbus Register	Modbus Address	No.of Byte	Data Type	Description	Default Setting	Read Write	Comment
14273	14272	10	string	Unit Name 35	kpa	R	UTF8 string (max. 10 character)
14281	14280	10	string	Unit Name 36	Mpa	R	UTF8 string (max. 10 character)
14289	14288	10	string	Unit Name 37	mbar	R	UTF8 string (max. 10 character)
14297	14296	10	string	Unit Name 38	bar	R	UTF8 string (max. 10 character)
14305	14304	10	string	Unit Name 39	psi	R	UTF8 string (max. 10 character)
14313	14312	10	string	Unit Name 40	mV	R	UTF8 string (max. 10 character)
14321	14320	10	string	Unit Name 41	V	R	UTF8 string (max. 10 character)
14329	14328	10	string	Unit Name 42	μV	R	UTF8 string (max. 10 character)
14337	14336	10	string	Unit Name 43	kV	R	UTF8 string (max. 10 character)
14345	14344	10	string	Unit Name 44	mA	R	UTF8 string (max. 10 character)
14353	14352	10	string	Unit Name 45	A	R	UTF8 string (max. 10 character)
14361	14360	10	string	Unit Name 46	kg/s	R	UTF8 string (max. 10 character)
14369	14368	10	string	Unit Name 47	kg	R	UTF8 string (max. 10 character)
14377	14376	10	string	Unit Name 48	∅ m³/h	R	UTF8 string (max. 10 character)
14385	14384	10	string	Unit Name 49	∅ l/h	R	UTF8 string (max. 10 character)
14393	14392	10	string	Unit Name 50	∅ kg/h	R	UTF8 string (max. 10 character)
14401	14400	10	string	Unit Name 51	∅ cf/h	R	UTF8 string (max. 10 character)
14409	14408	10	string	Unit Name 52	kg/h	R	UTF8 string (max. 10 character)
14417	14416	10	string	Unit Name 53	kg/min	R	UTF8 string (max. 10 character)
14425	14424	10	string	Unit Name 54	Ω	R	UTF8 string (max. 10 character)
14433	14432	10	string	Unit Name 55	Hz	R	UTF8 string (max. 10 character)
14441	14440	10	string	Unit Name 56	%	R	UTF8 string (max. 10 character)
14449	14448	10	string	Unit Name 57	kW	R	UTF8 string (max. 10 character)

Modbus Register	Modbus Address	No.of Byte	Data Type	Description	Default Setting	Read Write	Comment
14457	14456	10	string	Unit Name 58	kWh	R	UTF8 string (max. 10 character)
14465	14464	10	string	Unit Name 59	PCS	R	UTF8 string (max. 10 character)
14473	14472	10	string	Unit Name 60	kVA	R	UTF8 string (max. 10 character)
14481	14480	10	string	Unit Name 61	kVAr	R	UTF8 string (max. 10 character)
14489	14488	10	string	Unit Name 62	-	R	UTF8 string (max. 10 character)
14497	14496	10	string	Unit Name 63	€	R	UTF8 string (max. 10 character)
15505	15504	10	string	Unit Name 64	cts/m ³	R	UTF8 string (max. 10 character)

9. Appendix

9.1 APPENDIX A - Exception codes

The BDL Modbus uses the following exception codes when responding to the client

Exception Code	Exception name
0x01	Illegal function
0x02	Illegal data address
0x03	Illegal data value
0x04	server device failure
0x05	Acknowledge
0x06	server device busy

BEKO TECHNOLOGIES GmbH

Im Taubental 7
 D - 41468 Neuss
 Tel. +49 2131 988 0
 Fax +49 2131 988 900
 info@beko-technologies.com
 service-eu@beko-technologies.com

DE**BEKO TECHNOLOGIES LTD.**

Unit 11-12 Moons Park
 Burnt Meadow Road
 North Moons Moat
 Redditch, Worcs, B98 9PA
 Tel. +44 1527 575 778
 info@beko-technologies.co.uk

GB**BEKO TECHNOLOGIES S.à.r.l.**

Zone Industrielle
 1 Rue des Frères Rémy
 F - 57200 Sarreguemines
 Tél. +33 387 283 800
 info@beko-technologies.fr
 service@beko-technologies.fr

FR**BEKO TECHNOLOGIES B.V.**

Veenen 12
 NL - 4703 RB Roosendaal
 Tel. +31 165 320 300
 benelux@beko-technologies.com
 service-bnl@beko-technologies.com

NL**BEKO TECHNOLOGIES
(Shanghai) Co. Ltd.**

Rm.715 Building C, VANTONE Center
 No.333 Suhong Rd.Minhang District
 201106 Shanghai
 Tel. +86 (21) 50815885
 info.cn@beko-technologies.cn
 service1@beko.cn

CN**BEKO TECHNOLOGIES s.r.o.**

Na Pankraci 58
 CZ - 140 00 Praha 4
 Tel. +420 24 14 14 717 /
 +420 24 14 09 333
 info@beko-technologies.cz

CZ**BEKO Tecnológica España S.L.**

Torruella i Urpina 37-42, nave 6
 E - 08758 Cervelló
 Tel. +34 93 632 76 68
 Mobil +34 610 780 639
 info.es@beko-technologies.es

ES**BEKO TECHNOLOGIES LIMITED**

Room 2608B, Skyline Tower,
 No. 39 Wang Kwong Road
 Kwoloon Bay Kwoloon, Hong Kong
 Tel. +852 2321 0192
 Raymond.Low@beko-technologies.com

HK**BEKO TECHNOLOGIES INDIA Pvt. Ltd.**

Plot No.43/1 CIEEP Gandhi Nagar
 Balanagar Hyderabad
 IN - 500 037
 Tel. +91 40 23080275 /
 +91 40 23081107
 Madhusudan.Masur@bekoindia.com
 service@bekoindia.com

IN**BEKO TECHNOLOGIES S.r.l**

Via Peano 86/88
 I - 10040 Leinì (TO)
 Tel. +39 011 4500 576
 Fax +39 0114 500 578
 info.it@beko-technologies.com
 service.it@beko-technologies.com

IT**BEKO TECHNOLOGIES K.K**

KEIHIN THINK Building 8 Floor
 1-1 Minamiwatarida-machi
 Kawasaki-ku, Kawasaki-shi
 JP - 210-0855
 Tel. +81 44 328 76 01
 info@beko-technologies.jp

JP**BEKO TECHNOLOGIES Sp. z o.o.**

ul. Pańska 73
 PL - 00-834 Warszawa
 Tel. +48 22 314 75 40
 info.pl@beko-technologies.pl

PL**BEKO TECHNOLOGIES S. de R.L. de C.**

BEKO Technologies, S de R.L. de C.V.
 Blvd. Vito Alessio Robles 4602 Bodega 10
 Zona Industrial
 Saltillo, Coahuila, 25107
 Mexico
 Tel. +52(844) 218-1979
 informacion@beko-technologies.com

MX**BEKO TECHNOLOGIES, CORP.**

900 Great Southwest Pkwy SW
 Atlanta, GA 30336
 USA
 Tel. +1 404 924-6900
 beko@bekousa.com

US